

1990 Vanagon/Transporter

Volkswagen
Owner's
Manual



Your Volkswagen Vanagon/Transporter has been conceived with the classic German passion for engineering excellence. Even in Germany, Volkswagen engineers are a breed apart. They are never just content to compete, they must excel.

A labor of love

Volkswagen engineers are innovators. They employ the most sophisticated technology, and when it is lacking, they create it themselves. They are perfectionists. They insist that their own craftsmanship undergoes inspection after inspection to assure that every Volkswagen is as perfect as man and machine can make it. They are practical.

They have built efficiency, reliability and durability into every Volkswagen that truly make it a great automotive value.

Share the feeling

But above all, Volkswagen engineers share a passion for performance, the results of which you will experience when you slip behind the wheel. Only then will you fully understand that you're not just driving a car, you're driving a Volkswagen.



Your new Volkswagen

may have all or some of the equipment described in this manual. Therefore, you may find explanations of equipment not installed in your vehicle.

Check with your authorized Volkswagen dealer on available options or accessories.

Your Owner's Manual

applies to all Vanagon/Transporter models currently sold in the USA and Canada. It contains important operating safety information. Keep this booklet in your glove box at all times for ready reference.

Read it before you drive your new vehicle. Pay particular attention to the "Break-in period hints" and to all points listed under "Vehicle operation".

Acquaint yourself with your vehicle's features and know how to operate it more safely. The more you know about your Volkswagen, the more you will enjoy driving it. For your own protection and longer service life of your vehicle, always heed our instructions and warnings. Ignoring them could result in extensive damage or serious personal injury.

Note

WARNINGS concern safety and are color identified throughout this manual.

Please note that the items of equipment marked with an asterisk* may be standard on certain models but are only available as options on other models.

In addition to this Owner's Manual, your Vanagon/Transporter comes with

- the Radio Operating Instructions*,
- the Warranty Booklet and
- the Maintenance Booklet.

Your Warranty booklet

which is a separate brochure, contains detailed information about the warranties covering your Volkswagen.

Your Maintenance booklet

which is a separate brochure, explains how you can keep your Volkswagen in top driving condition by having it serviced regularly. Always have the Maintenance booklet with you when you take your vehicle to a Volkswagen dealer for service. Your Service Adviser will record each scheduled service.

In Canada,

these manuals are also available in French. To obtain a copy, contact your dealer or write to:

Au Canada on peut se procurer un exemplaire de ce Manuel en français auprès du concessionnaire ou du:

Volkswagen Canada, Inc.
Customer Assistance/
Assistance à la Clientèle
1940 Eglinton Ave. East
Scarborough, Ontario
M1L 2M2

If you sell your Volkswagen

the Owner's Manual, the Warranty booklet and the Maintenance booklet should be left in the vehicle to make Warranty terms as well as all operating, safety and maintenance information available to the next owner.

If you change your address or if you bought this Volkswagen used

be sure to send in a "Notice of Address Change"/"Notice of Used Car Purchase" post card. This card can be found in the Warranty booklet or obtained from your Volkswagen dealer.

It is in your own interest that we can contact you should the need arise.

INSTRUMENT PANEL

Illustration instruments and controls . . .	4
Warning and indicator light symbols . . .	6

CONTROLS AND EQUIPMENT

Keys, central locking system	7, 8
Doors	9
Rear lid	11
Windows, mirrors	12, 13
Safety belts, head restraints	14, 19
Seats	20
Luggage compartment, pedals	28, 29
Brakes, Transmission	29, 32
Differential lock	33
Automatic-transmission	35
Steering lock/ignition/starter switch	38
Starting procedures	39
Instrument cluster	40
Warning/indicator lights	43
Switches	46
Emergency flasher	46
Light switch, turn signals	46, 48
Cruise control	49
Windshield wipers	50
Ventilation/Heating	51
Air conditioning	54
Heater	57
Sliding roof	62
Roofrack	68

VEHICLE OPERATION

Break-in period – and afterwards	69
Operate your vehicle safety	70
Operate your vehicle economically and minimize pollution	72
Trailer towing	73
Driving with the all-wheel drive	75

VEHICLE CARE

Fuel tank, fuel supply	85, 86
Vehicle care (exterior/interior)	90, 93
Maintenance, inspection intervals	95
Engine compartment lid, engine compartment	97
Lubricants, engine oil	98, 99
Engine oil filter	101
Transmission oil	102
Power steering	103
Cooling system	104
Brake fluid	108
Battery	109
Windshield washers/wipers	112, 113
Tires/wheels	114
Difficult operating conditions	120
Winter driving	121
Accessories	122

DO-IT-YOURSELF SERVICE

Jack and tools	123
Spare wheel	124
Changing a wheel	125
Fuses, bulbs	128, 130

Adjusting headlights	134
Installing, replacing the radio	135
Emergency starting	136
Emergency towing	138
Lifting vehicle	140

TECHNICAL DESCRIPTION

Engine, transmission	142
Steering, suspension, brakes, body, chassis	143
Emission-control-system	144

TECHNICAL DATA

Engine, spark plugs	146
V-belts capacities	147
Dimensions	148
Weights	150
Vehicle identification	151

CONSUMER INFORMATION

Service manuals	152
---------------------------	-----

GAS STATION INFORMATION

Location of servicing points	156
--	-----

ALPHABETICAL INDEX . . . 158

INSTRUMENT PANEL AND CONTROLS

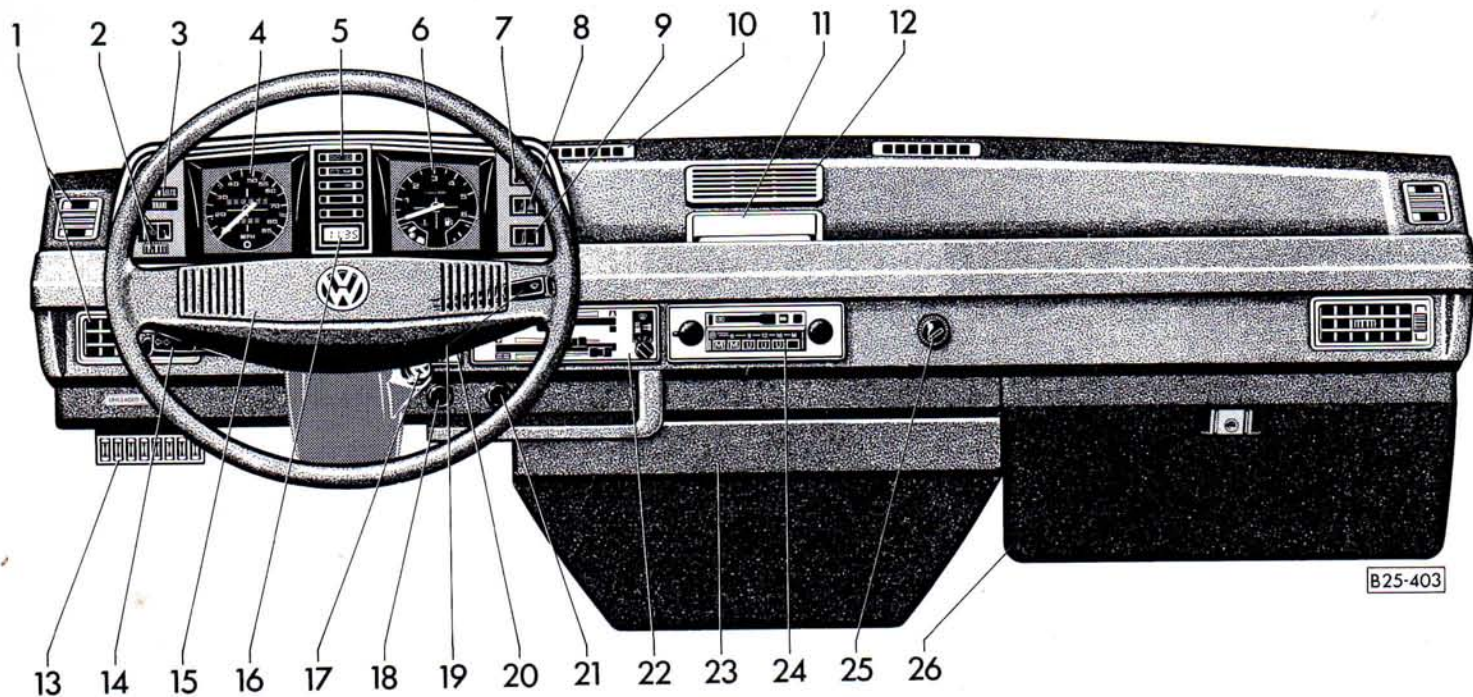

INSTRUMENT PANEL AND CONTROLS

	page
1 – Air vents	51
2 – Light switch and thumb wheel for instrument illumination	46
3 – Safety belt and brake warning lights	43, 47
4 – Speedometer with trip odometer	40
5 – Warning/indicator lights	6, 43
6 – Clock or tachometer with fuel gauge and coolant temperature gauge	40, 41
7 – Rear window defogger switch	47
8 – Emergency flasher switch	46
9 – For additional switch	
10 – Air vents, left and right	51
11 – Ashtray	64
12 – Loudspeaker grille	
13 – Fuses	128
14 – Turn signal/headlight dimmer switch lever	48
15 – Horn	

	page
16 – Digital clock	40
17 – Steering lock/ignition/starter switch	38
18 – Temperature switch for auxiliary heater	57
19 – Windshield wiper/washer lever	50
20 – Secondary heat exchanger switch	53
21 – Emission Control System (ECS)	45
22 – Climate controls	51
23 – Air vents	51
24 – Radio ¹⁾	
25 – Cigarette lighter	63
26 – Glove compartment	64













¹⁾ A separate brochure is provided for your factory-installed radio. If you replace your radio, please be sure to read the notes in the chapter “Do-it-yourself Service”, page 135.

Note

Some features mentioned are standard equipment on some models only or are options on others.

INSTRUMENT PANEL AND CONTROLS

WARNING AND INDICATOR LIGHT SYMBOLS

Symbol		Details on page
	Turn signals	44, 48
	Alternator	 44
	Oil pressure	 43
	High beam	45, 48
	Coolant temperature	 45, 104
 BRAKE	Brake	 29, 43
	Safety belt	14, 44
	Emergency flasher	46
	Rear window defogger	47

WARNING

If one of the lights marked with  comes on suddenly while driving, move a safe distance off the road. Turn off the engine, turn the emergency flasher on and use other warning devices to alert other motorists. Go to listed page in your Owner's Manual for explanations.

Some of the lights mentioned are on certain models only and may be options on other models.

KEYS

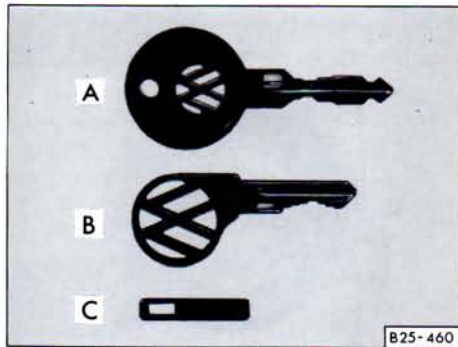

Your Volkswagen comes with four keys:

- two keys A
- two keys B

Key A can be inserted into locks either way.

Key A is used for the ignition/steering lock, the doors, the lockable tank cap and the rear luggage compartment lid.

Key B is provided for vehicles equipped with a lockable glove compartment.

Tag C gives the key number.

For your protection against theft:

- Record the key number and keep it in a safe place, such as your wallet. Do not keep it in the vehicle.
- If you should lose a key, provide your Volkswagen dealer with the key number to obtain a duplicate key.

In addition to the plastic tag, there may also be a metal tag showing part of the vehicle identification number. This tag is no longer required after the vehicle has been delivered.

Note

The syncro model has a separate key for the lockable tank cap.

■ **Do not leave your vehicle unattended with the key in the ignition lock. Always take the key and lock the doors.**

A chime will sound when you open the driver's door with the key left in the ignition lock. This is your reminder to remove the key and lock the doors.

WARNING

■ **Do not leave children unattended in the vehicle especially with access to vehicle keys. Unsupervised use of the keys can result in starting of the engine and use of vehicle systems such as power windows etc. Unsupervised use of these systems can result in serious personal injury.**

■ **Do not remove key from steering lock while you are driving or as the vehicle is rolling to a stop. The steering column will lock when you remove the key, and you will not be able to steer the vehicle.**

CONTROLS AND EQUIPMENT

CENTRAL LOCKING SYSTEM*

The central locking system locks or unlocks doors and rear lid simultaneously. It is actuated from the driver's and passenger's door.

■ To lock and unlock from the outside, turn key in lock of driver's and passenger's door.

■ To lock and unlock from the inside, raise or depress locking knob on window sill of driver's and passenger's door.

When you unlock the driver's and passenger's door with the key from the outside or raise the locking knobs from the inside, wait until both locking knobs are raised before you open one of the doors.

When the central locking system is actuated, both locking knobs on window sills should move simultaneously. If one knob does not move when locking doors, open that particular door and close it properly.

Sliding door and rear lid can be locked and unlocked individually with the key; manual lock operation will override the power lock system.

WARNING

■ Locking doors from the inside can help prevent inadvertent door opening during an accident and generally while the vehicle is in motion. Locked doors can also prevent unwanted entry from the outside.

Locked doors can, however, also delay assistance to vehicle occupants and rescue from the outside in the event of an accident or other emergency.

■ Do not leave children inside the vehicle without supervision. If locking knob in driver's and passenger's door is depressed, both doors will be locked automatically. In an emergency it would be impossible to open the doors from outside without the key.

Rear lid

■ With the key slot in horizontal position (a), the lid can be locked and unlocked by the central locking system.

■ With key slot in vertical position (b), the rear lid remains locked when actuating the central locking system.

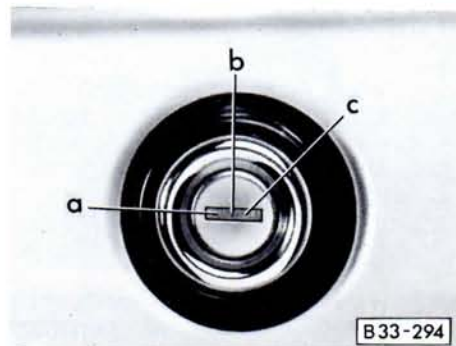

If the rear lid is closed with lock slot in vertical position, the luggage compartment can only be opened with the master key:

- Insert key in lock slot.
- Turn key all the way to the right (c) and hold in this position.
- Press lock cylinder in and raise lid.
- Remove key.

DOORS

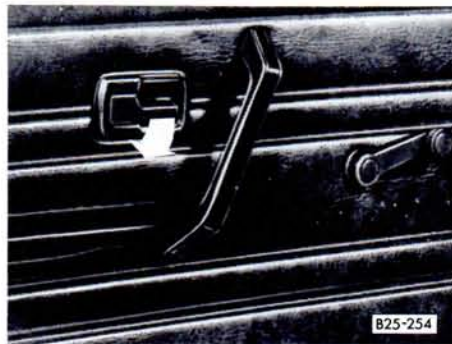
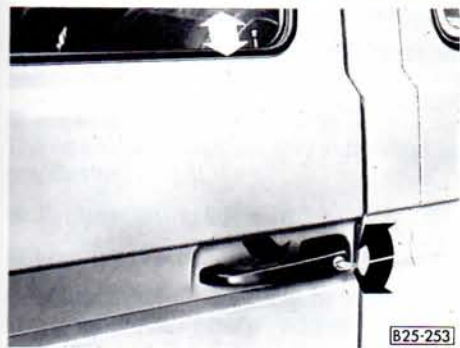

Front doors

To lock, unlock and open doors from the outside

- Lock and unlock the front doors by turning the key to the right or left.

- Open the doors by squeezing the trigger in the outer door handle.

- The passenger's door can be locked without a key. First depress the locking knob, then close the door.

- The driver's door can only be locked from the outside with the key. This precaution was taken to prevent locking the driver's door while the key is still inside the vehicle.

To lock, unlock and open doors from the inside

- To lock doors depress the locking knob.

- To unlock doors raise the locking knob.

- To open doors pull the inside door handle after raising the locking knob.

WARNING

Locking doors from the inside can help prevent inadvertent door opening during an accident and generally while the vehicle is in motion. Locked doors can also prevent unwanted entry from the outside.

Locked doors can, however, also delay assistance to vehicle occupants and rescue from the outside in the event of an accident or other emergency.

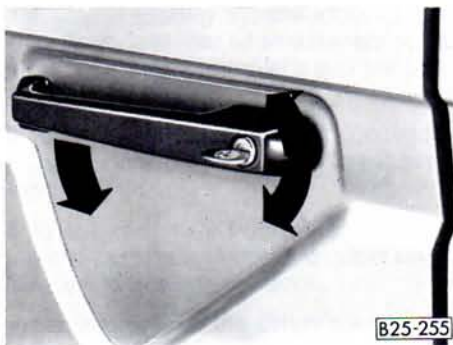

Sliding door

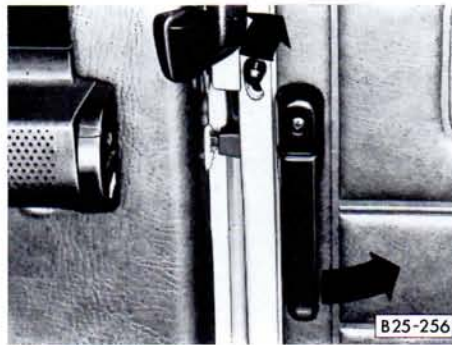

Always drive with a fully latched sliding door.

To open from the outside

- Unlock the door with the key.
- Then press the handle down and slide the door to the rear. The door is held in the fully open position by a catch.

WARNING

Make sure the catch is fully engaged. Otherwise, the door could slide forward by itself and cause injury to entering or exiting passengers.

To close and lock from the outside

- Press the handle down to release the catch. Slide the door forward until it is closed.

You can only lock and unlock the sliding door from the outside with the key.

To open from the inside

- Move the small sliding knob up and pull the handle back.

To close and lock from the inside

- Pull the handle forward to release the catch, close the door and move the small sliding knob down.

In the VANAGON Kombi and VANAGON Delivery Van

Cargo area

Make sure the cargo compartment floor area is loaded correctly, to permit unobstructed operation of the sliding door.

Do not transport people in the cargo area.

REAR LID

To unlock the rear lid, use the key A.

- Insert key into vertical lock slot position and turn to left.
- Press lock cylinder in and lift lid.
The open hatchback will stay in position at any desired height.
- To close, swing lid down.
- Lock with key.

Be careful when loading or removing large objects. Sharp edged articles may damage the defogger wires in the rear window.

For safety reasons keep the rear lid locked at all times.

WARNING

To help prevent poisonous exhaust gas from being drawn into the vehicle, always keep the rear lid closed while driving.

Do not transport objects larger than those fitting safely into the luggage area.

CONTROLS AND EQUIPMENT

WINDOWS

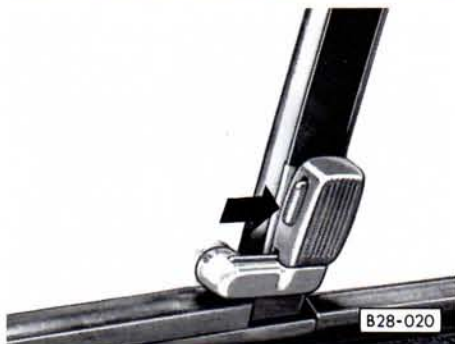

Vent windows*

- To open, press button in latch and turn the latch.
- To close, press vent window against seal and turn latch until button engages.



Sliding windows*

To open, press locking knob down and slide window open.

Door windows

Lower and raise the windows with the windows in the door panels.

WARNING

Do not put anything on or near the windows that may interfere with the driver's vision.

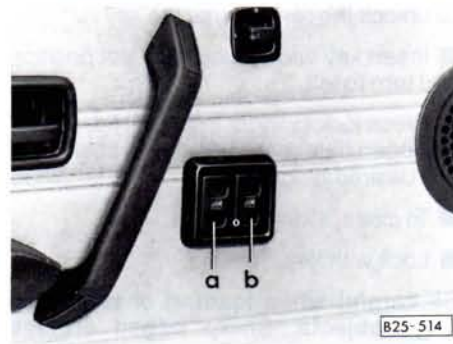

Power windows*

The window control switches are located in the door panels. The right window can also be operated from the driver's door by a separate switch.

The power windows work only with the ignition on.

- a – driver's door
- b – right door

WARNING

Do not leave children unattended in the vehicle especially with access to vehicle keys. Unsupervised use of the keys can result in starting of the engine and use of vehicle systems such as power windows, etc. Unsupervised use of these systems can result in serious personal injury.

MIRRORS

Adjust the outside and inside mirrors before driving and after adjusting your seat to proper driving position. It is important for safe driving that you have good vision to the rear.

WARNING

The right hand outside mirror may have a curved (convex) surface. Always remember that vehicles or other objects seen in a convex mirror will look smaller and appear farther away than when seen in a flat mirror. Do not use this mirror to estimate distances of following cars when changing lanes. Whenever possible, use the inside mirror to determine the actual distance and size of vehicles or objects seen in the convex mirror.

Outside mirrors

The outside mirrors are hinged and fold flat against the vehicle when pressed from either direction.

Fold mirrors flat against the side windows when taking your vehicle through an automatic car wash to prevent possible damage.

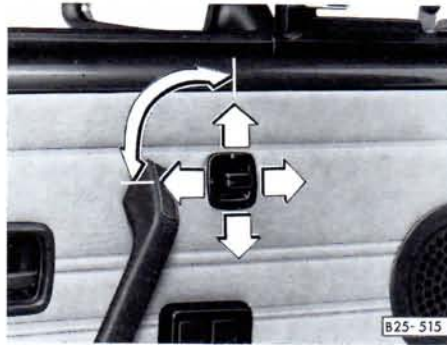

Outside mirrors with electric remote control*

These mirrors can be adjusted electrically from the inside by moving the knob on the driver's door panel. They work only with the ignition on. To adjust either driver or passenger mirror, turn knob to L or R.

If the electrical adjustment of the mirror should not respond, adjust the mirror by hand by pushing lightly on the edge of the mirror glass.

When the rear window defogger is switched on, the outside mirrors are electrically heated at the same time (see page 47).

*where applicable

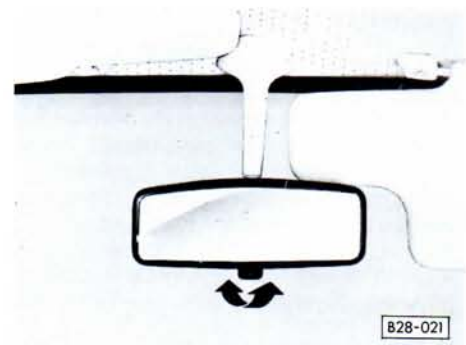

Inside day-night mirror

You can adjust the day-night mirror from clear daylight visibility to non-glare visibility at night by moving the lever at the bottom of the mirror.

To ensure the best possible anti-glare effect, the lever should be pointing forwards when the basic mirror setting is made.

daylight driving – lever front
 night driving – lever rear

CONTROLS AND EQUIPMENT

SAFETY BELTS

WARNING

Safety belts have been shown to be the single most effective means available for reducing the potential for serious injury and death in automobile accidents. Therefore for your own protection as well as that of your passengers always properly wear safety belts when the vehicle is in motion. Also, pregnant women, injured or physically impaired persons should use safety belts.

In order to provide the maximum level of protection safety belts must be properly positioned on the body. Improperly positioned safety belts can cause serious personal injury in case of an accident. Therefore read and always observe all of the following instructions and warnings pertaining to the use of the safety belts installed in your vehicle.

- The shoulder belt should be positioned midway over the shoulder never across the neck. See illustration on page 17.

- Always make certain that the safety belt tongue is inserted into the safety belt buckle associated with the corresponding seat. Attaching the safety belt

to the buckle for another seat could reduce safety belt effectiveness and cause injury.

- Do not wear shoulder part of belt under your arm or otherwise out of position. This would increase the risk of serious injury in case of an accident.

- Do not use comfort clips or devices which create slack in the shoulder belt portion and can increase the risk of injury in an accident. However such clips may be required in the proper use of some child restraint systems.

- Never strap in more than one person, including small children, with each belt. It is especially dangerous to place a safety belt over a child sitting on your lap.

- The lap belt must be worn low and tight across the pelvis. Make sure any slack is wound on the retractor.

- Belts should not be worn twisted.

- Do not wear belts over rigid or breakable objects in or on your clothing, such as eye glasses, pens, keys, etc. as these may cause injury.

- Several layers of heavy clothing may interfere with proper positioning of belts and reduce the overall effectiveness of the system.

- Keep belt buckles free of any obstruction that may prevent secure locking.

- Make sure the belts of the unoccupied seats are in their stowed positions.

- Belts that have been subjected to excessive stretch forces in an accident must be replaced.

- Belts must not rub against sharp objects.

- Do not allow safety belts to become damaged by becoming caught in door or seat hardware.

- Inspect your belts periodically. If belts show damage to webbing, bindings, buckles or retractors, they must be replaced.

- If belts do not work properly, see your Volkswagen dealer.

- Do not modify or disassemble the safety belts in your vehicle.
- The belts must be kept clean as otherwise the retractors may not work properly (also see "Vehicle care", page 93).
- Never bleach or dye safety belts.
- Do not allow safety belts to retract until they are completely dry.

Child safety

WARNING

All vehicle occupants and especially children should be restrained whenever riding in cars. Holding a child in your arms is not a substitute for a child restraint system. In an accident, a child held in a person's arms can be struck or crushed by any unrestrained rider. An unrestrained child could also be injured by striking the interior, or by being ejected from the vehicle during a sudden maneuver or impact. Do not allow children to stand or kneel on the seat. A child restraint system can help protect a child in a car.

Accident statistics have shown that children are generally safer in the rear seat area than in the front seating positions.

A suitable child restraint properly installed and used in one of the rear seating positions provides the highest degree of protection for infants and small children in most accident situations.

Commercially available child seats are required to comply with U.S. Federal Motor Vehicle Safety Standard (FMVSS) 213 (or in Canada, CMVSS 213). These standards include installation requirements which utilize a lap belt or the lap portion of a combination lap-shoulder belt such as that installed in your vehicle.

Should these safety belts be too short, a special lap belt adapter is available from your Volkswagen dealer.

When purchasing a child restraint, select one which properly fits your child and your car.

Only use child restraint systems which fully contact the flat portion of the seat cushion. The child seat must not tip or lean to either side. We do not recommend the use of child seats which rest on legs or tube like frames because they do not provide adequate contact with the seat.

WARNING continued

Improperly or inadequately installed child restraint systems can increase the risk of injury to children in accidents, therefore always carefully read and follow all instructions on installation and use that come with the system.

Children must be positioned so that the shoulder belt does not contact or remain in front of the face, chin, neck or throat. Failure to follow this precaution can increase the risk or severity of injury in the event of a collision.

In summary:

Children who are less than 12 years old should always sit in the rear.

For reasons of safety a child should only occupy the front seat if all of the rear seating positions are already occupied by other children.

The children should wear, depending on age and body size, either a child restraint system or the existing safety belts:

■ Babies and children up to about 6 or 7 years should be secured with a child restraint system designed for their size.

Children of average size of about 6 or 7 years of age may use available safety belts. Always make sure that the shoulder portion of a three point belt is positioned midway over the shoulder – it must never rest against or across the neck. See illustration page 17. The lap belt or the lap belt portion of the three point belt must always pass as low as possible across the pelvis, never over the abdomen.

If the safety belt will not properly fit the child, we recommend the use of a suitable booster seat in a rear seating position in order to raise the child's seating height so that the safety belt will properly fit the child.

Belt height adjustment

There are two different anchorage points for the front safety belts in the door pillars on each side.

The belt relay fitting is normally mounted on the upper anchorage point. For proper positioning of the shoulder section of the safety belt it may be necessary to remount the relay fitting on the lower anchorage point.

Lap-shoulder belt

The combination lap-shoulder belt is equipped with a locking retractor. The system adjusts automatically to your size and movements as long as the pull on the belt is slow.

Hard braking or a collision locks the belt. The belt will also lock when you drive up or down a steep hill or in a sharp curve.

Before fastening the seat belt first adjust seat – see page 20.

- To fasten, grasp belt tongue and pull belt in continuous slow motion across your chest and lap.

- Insert belt tongue into buckle on in-board side of seat. Push down until it is securely locked with an audible click. Pull belt to check.

- Pull upwards on shoulder section to make sure belt fits snugly across the pelvis.

The shoulder belt must be positioned midway over the shoulder – **it must never rest against the neck**. See illustration.

- Belts should fit snugly across the pelvis and chest. **Make sure any slack is wound up on the retractor.**



- Adjust height of belt anchorage, if necessary. Do not wear shoulder part of belt under your arm or otherwise out of position. This would increase the possibility of serious injury in case of an accident.

- To unfasten belt, push in release button on buckle. Belt will spring out of buckle.

- To release a locked belt, lean back to take the body pressure off the belt.

- To store lap-shoulder belt, allow belt to wind up on retractor as you guide belt tongue to its stowed position.

Always heed WARNINGS on page 15, 16, 17.

Belt warning system

An audio-visual warning system is interconnected with the driver's safety belt.

Every time the ignition is turned on, the safety belt warning light will come on for about six seconds as a reminder to buckle up. If the driver does not fasten the safety belt, the chime will also come on for six seconds. With the driver's door closed, the chime will go off as soon as the driver has buckled up.



Lap belts

Seats in the passenger compartment are equipped with adjustable lap belts.

The belts must always be kept on top of the seat for ready use. Do not permit them to get caught under the seat.

■ To lengthen belt, hold belt tongue at a right angle to belt and loop out the required portion. For ease of operation, press cap and tongue of buckle together.

■ To tighten belt, buckle up and pull at loose end of the belt.

Take up any slack by moving the slide on the belt.

WARNING

■ **To reduce the risk of injury in an accident, position the lap belt as low as possible across the pelvis.**

■ To fasten lap belt, grasp belt tongue on outboard side of seat, pull across pelvis and insert in inboard buckle.

■ To unfasten belt, push release marked **PRESS** in the buckle.

During pregnancy

Pregnant women should always wear safety belts. The lap belt must be worn as snugly and as low as possible across the pelvis. **To avoid pressure on the abdomen the belt must never pass over the waist.**

Injured persons and the physically impaired

We recommend that injured persons and the physically impaired wear safety belts whenever possible. Although the instructions provided above still apply, your doctor can give you special recommendations when necessary.

Always heed WARNINGS on page 14, 15, 16.

HEAD RESTRAINTS



B25-281

WARNING

Do not drive the vehicle without the head restraint provided. Head restraints are designed to help reduce injuries.

The padded head restraints on front and rear* seats are adjustable.

Position head restraints according to the occupant's height. Only properly positioned head restraints, together with the use of safety belts offer effective protection.

- For height adjustment, grasp firmly with both hands and pull up or push down.
- For maximum protection the upper edge should be at eye level.

*where applicable

CONTROLS AND EQUIPMENT

SEATS IN DRIVER'S CAB



Height adjustment of head restraints

Head restraints must be adjusted according to seating height of the respective occupant. See page 19.

Armrests*

The armrests on the front seats can be hinged up if they are not required.

The angle of the armrests can be adjusted as required with a knurled knob underneath the armrest.

WARNING

■ For driver's and passenger's protection make sure front seats are securely latched in place.

■ Do not adjust seats while the vehicle is in motion. Your seat may move unexpectedly which could cause sudden loss of vehicle control or personal injury.

■ The front seats should be adjusted before fastening the safety belt.

Bucket seat

Seat adjustment (forward or backward)

The bucket seats can be adjusted individually.

■ Pull up lower lever (1) at outboard side of seat.

■ Slide seat to desired position.

■ Release the lever and move seat slightly back and forth to make sure the seat is securely locked.

Seatback adjustment

The backrest is secured and cannot tilt forward accidentally.

■ To adjust, take body weight off the backrest and push down lever (2) at hinge cover on right side of seat.

■ Exert slight body pressure in the direction desired and let lever go to lock backrest in position.

WARNING

To reduce the risk of serious personal injury in an accident, front seat passengers must never ride in a moving vehicle with the seatback reclined. The risk of personal injury will increase with increasing rearward angle of the seatback. Safety belts only offer optimum protection when the seatback is upright and belts are properly positioned on the body. Improperly positioned safety belts cause serious personal injury in an accident.

Removing bucket seats

■ Stand outside vehicle, pull up lever (1) and slide seat all the way forward.

■ Lift stop hook (3) up against springloading, hold there and slide seat past stop.

■ Release stop hook and slide seat forward out of guide rails.

When reinstalling seat, reverse the above procedure. The stop hook (3) need not be lifted as the seat can just be pushed past the stop.

Two-seater*

Seat adjustment (forward or backward)

The two seater adjustment lever is located in front of the seat.

The adjustment procedure outlined for the front bucket seats also applies to the two seater.

The backrest adjusts at the same time the adjustment lever is operated.

Removing two seater

First remove bolts from the upper hinge on the backrest.

Then proceed as outlined for removal of the bucket seats.

*where applicable

Swivel seats*

The forward or backward adjustment procedure outlined for the front bucket seats also applies to the swivel seats.

Before turning the driver's swivel seat:

- Position shift lever in park (automatic transmission) or in first gear (manual transmission).
- Block wheels if necessary to prevent vehicle from moving.
- Release parking brake.

WARNING

Swivel seats must be in forward facing position while driving. Do not operate the locking lever of the swivel seat while the vehicle is in motion.

To swivel the seat, move seat slightly forward or open the door a crack. Then push down the locking lever in front of the seat. The **passenger** seat can be turned 180° to the **left** (half circle).

The **driver's** seat can be turned 90° to the right (quarter circle).

The seats will lock automatically at every turn.

SEATS IN PASSENGER COMPARTMENT

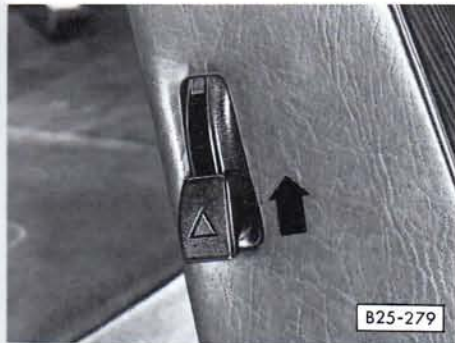

In the 9-seater version the backrest of the first seat in the middle row can be tilted forward and out of the way for easy access to the rear bench. To disengage the lock of the backrest, pull up the lever on the side of the backrest.

WARNING

For your passenger's protection, the backrest lock must be engaged at all times while the vehicle is in motion.

Removing and installing the center bench seat

The center bench seat slides into two holding rails and is fastened in place by four screws.

To remove the seat:

- Lift the floor covering and remove the screws.
- Pull the bench seat out of the holding rails and remove the seat through the sliding door.

Note

On vehicles with floor carpeting, you must first unscrew the mounting strip and carefully lift the carpet up. Be sure not to tear the carpeting.

When reinstalling the bench seat, make sure that the holding rails are clean.

WARNING

To prevent personal injury, the seat must always be securely fastened into place while driving.

CONTROLS AND EQUIPMENT

SINGLE SEATS* IN PASSENGER COMPARTMENT



The seat cushion for the single seats can be folded up, or if necessary, the entire single seat can be easily removed.

Folding the seat cushions up

- Pull lever located below the seat and fold the cushion up until it locks into place.
- To lower the cushion, pull the lever and push the cushion down until it locks securely into position.



Removing the seat

- With one hand hold seat, with the other, pull release knob.
- Tilt seat forward and lift seat out.

WARNING

When pulling the release knob, the seat will tip forward. Therefore, never pull the knob when someone is sitting on the seat.



Installing the seat

- Place both rear legs into the holes in the floor panel (see illustration).
- Swing seat up until locking mechanism audibly locks into place. Visually check and pull on the seat to make sure the locking mechanism is securely engaged.

WARNING

To prevent personal injury, seat must always be securely fastened into place while driving.

■ The seatback for the folding seat may rub against the front seat backrest when the front seat is reclined. When this occurs, the locking mechanism of the folding seat may not securely engage. Before installing the folding seat, make sure that the front seatback is fully upright.

■ Attachment parts for the folding seats are individually fitted. Therefore, label the seats when removing both to prevent them from being interchanged when reinstalling. If the seats are interchanged the locking mechanism may not engage securely.

CONTROLS AND EQUIPMENT

REAR SEAT BENCH/BED COMBINATION*

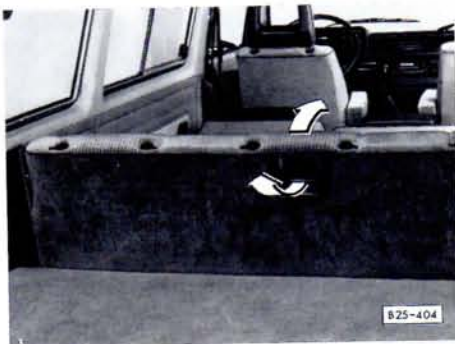

The rear seat bench can be converted into a full-size double bed. Before doing so, the backrests of the center seats* must be tilted forward. The locking levers are on the left and right outboard sides of the two backrests.

Unfolding rear seat bench

- Push safety belts between seat cushion and backrest.
- Unlock backrest with handle located on backside and tilt backrest forward.
- Keep hold of the handle and swing backrest together with seat cushion further forward



- Tilt backrest of bench all the way toward rear to form the bed.

Repositioning rear seat bench

- Pull backrest section up.
- Swing seat cushion and backrest toward rear again.
- Make sure the backrest is locked securely into position.
- Pull safety belts out again to be ready for use.



WARNING

Do not place heavy or sharp edged objects on the rear deck mattress to avoid damaging the upholstery. Such objects may also become dislodged while driving and cause injury.

- Do not use the double bed to carry passengers.
- Do not allow children to sit or kneel on the rear deck while the vehicle is in motion.
- When the car is in motion, make sure that the seat bench is securely locked in an upright position and that passengers wear safety belts.

CURTAINS*

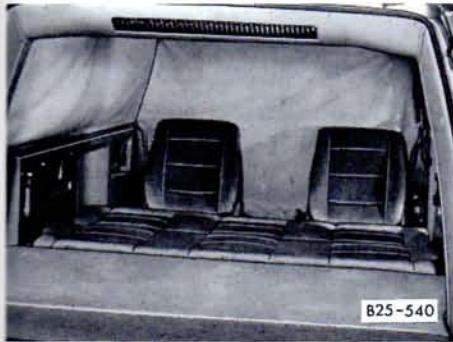

The compartment underneath the seat bench can be used for storage. To gain access to the storage space, lift the seat cushion up. To hold the seat cushion in an upright position, prop with the support rod located on the left side wall.

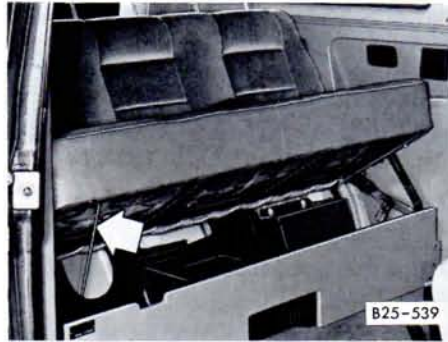

The curtains are stored under the rear seat bench.

The curtains cover the windows to give you complete privacy. They can be installed with the snap fasteners provided.

WARNING

Safe driving requires that you have an unobstructed view of the road at all times. Remember to reposition the curtains so that you have a clear view all around you before driving off.

CONTROLS AND EQUIPMENT

REAR SEAT/LUGGAGE COMPARTMENT



You can expand the luggage compartment load surface by folding the backrest of the rear seat bench down.

Folding backrest for rear seat bench

Unlock the backrest by pulling strap in driving direction. Fold backrest down until it rests on seat cushion.

The backrest will be locked automatically when returned to its upright position. Make sure the lap belts remain on top of the seat cushion, ready for use.

When folding the seatback up, make sure it securely locks into place. This will prevent objects in the luggage compartment from flying forward in case of a sudden stop.

Luggage compartment

Cargo weight should be located in the luggage compartment as far forward as possible.

Be careful when removing large objects through the rear lid. Sharp edged objects may damage the defogger wires in the rear window.

Keep the luggage compartment locked at all times to prevent unauthorized access to the vehicle.

WARNING

■ To help prevent poisonous exhaust gas from being drawn into the vehicle, always keep the rear lid closed while driving. Therefore, do not transport objects larger than those fitting safely into the luggage area.

■ Do not allow passengers to occupy the rear load surface while the vehicle is in motion.

To reduce the risk of personal injury during a collision or sudden maneuver:

■ When transporting luggage or other cargo, secure it in place to prevent such articles from shifting during a sudden stop.

■ If it is necessary to stow luggage or other items inside the passenger compartment, be sure that they cannot fly forward in an accident or sudden maneuver and injure occupants.

■ Never exceed the Gross Axle Weight Rating or the Gross Vehicle Weight Rating which are specified on the safety compliance sticker located on the left door jamb. Exceeding permissible weight ratings can result in vehicle damage, accidents and personal injury. See also page 150.

PEDALS

WARNING

■ The movement of the pedals must never be obstructed by a floor mat or any other object.

■ In case one of the two brake circuits fails, increased brake pedal travel is required to bring your vehicle to a full stop.

■ It should always be possible to depress the clutch and accelerator pedals fully.

■ All pedals must be able to return freely to their normal positions.

Only use floor mats which leave the pedal area free and can be secured with floor mat fasteners.

BRAKES

Functioning of brake system

Your vehicle is equipped with a power assisted hydraulic dual circuit brake system with disc brakes at the front and self-adjusting drum brakes at the rear. Both circuits function independently.

One brake circuit operates the front wheels and the other the rear wheels.

In the unlikely event of hydraulic failure of one circuit, **push the brake pedal down firmly and hold it in that position.** A mechanical linkage activates the second circuit, and you will be able to bring the vehicle to a stop.

WARNING

Failure of one brake circuit will impair the braking capability resulting in an increased stopping distance.

If one brake circuit fails, the other will still operate. However, you will notice an increased pedal travel when you step on the brake. Should you encounter such experience, bring your vehicle safely to a full stop.

Avoid driving the vehicle and have it towed to the nearest Volkswagen dealer or qualified workshop.

Brake operation and brake warning light

Make it a habit to check the operation of your brakes before driving. The brake warning light will light up while the engine is cranking and the parking brake is pulled and/or the brake fluid level is too low. For more details see "Brake warning light" on page 43.

Keep in mind that the braking distance increases very rapidly as the speed increases. At 60 mph or at 100 km/h, for example, it is not twice but four times longer than at 30 mph or at 50 km/h. Tire traction is also less effective when the roads are wet and slippery. Therefore, always maintain a safe distance from the vehicle in front of you.

Brake booster

The brake booster works only when the engine is running.

WARNING

When the vehicle is moving while the engine is not running, more force on the brake pedal is required to bring the vehicle to a stop.

Conditions affecting braking efficiency

Moisture or road salt

WARNING

■ Under certain climatic and operating conditions such as passing through water, driving in heavy rain or after washing the vehicle the effectiveness of the brakes can be reduced. In winter ice can accumulate on the brake pads, linings, discs and drums. Cautiously apply brakes for a test. Brakes will dry, ice coatings will be cleaned off after a few cautious brake applications.

■ Driving for an extended period of time on salt covered roads without using your brakes can also affect braking efficiency. The accumulated salt coating must be cleaned off the brake discs and brake pads by a few cautious brake applications.

■ Do not "ride the brakes" by resting your foot on the pedal when not intending to brake. This may cause the brakes to overheat, premature wear and increased stopping distance.

■ Before descending a steep grade, reduce speed and shift transmission into a lower gear or lower driving position to control speed. Do not ride the brakes or hold the pedal down too long, or too often. This could cause the brakes to get hot and diminish braking efficiency.

New brake pads or linings

■ New brake pads and linings do not have optimum friction properties and must be "broken in" during the initial 100 to 150 miles (150 to 200 kilometers) of normal city driving. You can compensate for this by applying more pressure on the brake pedal. This also applies later when new pads or linings are installed.

Brake fluid level

■ If the brake fluid level is too low, malfunctions or even a failure in the brake system could result. Therefore, it is important to check your brake fluid level regularly. See page 108 for more details.

Low brake fluid is indicated by the brake warning light (see page 43).

Failure of one brake circuit

If the brake pedal travel should suddenly increase, one of the brake circuits may have failed. Should this happen, you will be able to bring your vehicle safely to a stop, however, you will have to push harder on the brake pedal and it will take a longer distance to stop the vehicle. Contact your Volkswagen dealership for assistance.

Brake wear

The brakes on our automobiles are still subject to wear depending largely on operating conditions and driving habits. On vehicles which are driven mostly in stop-and-go city traffic or which are driven hard, the brake linings should be checked by your Volkswagen dealer more often than specified in the Maintenance brochure.

Front spoiler

If you install a front spoiler on your vehicle, be sure the air flow to the front brakes is not obstructed, otherwise the brake system could overheat.

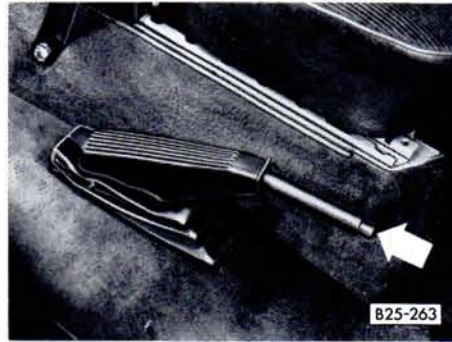

Parking brake lever

The parking brake lever is located between the front seats.

■ To set the parking brake, pull the lever until strong resistance is felt. The parking brake must be pulled up all the way so that the vehicle cannot be moved. When the ignition is on, the brake warning light will light up.

■ Depress brake pedal and hold while releasing parking brake. To release the parking brake, pull the lever slightly up, depress the release button (arrow), and then push the lever all the way down. When the parking brake is fully released, the brake warning light will go out.

WARNING

■ Release the parking brake fully. A partially engaged brake will overheat the rear brakes, reduce their effectiveness and cause excessive wear.

■ Always set the parking brake when parking your vehicle. Move the selector lever to "P" (Automatic transmission) or move the gearshift lever to "R" or "1" (Manual transmission). On hills also turn the wheels toward the curb.

CONTROLS AND EQUIPMENT

MANUAL TRANSMISSION

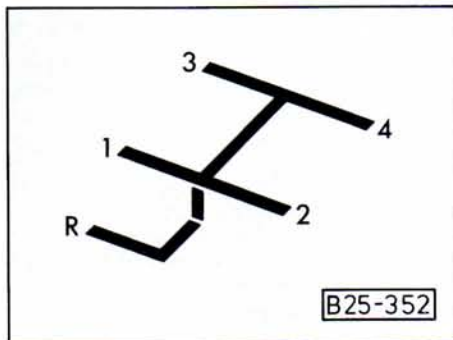

Gearshift lever

Start engine with gearshift lever in Neutral, clutch pedal depressed.

Always depress the clutch pedal fully when changing gears. Do not hold the vehicle on a steep hill with the clutch pedal partially depressed. This may cause premature clutch wear or damage.

Resting your hand on the shift lever knob while driving will cause premature wear in the transmission.

The forward gears and the reverse gear are arranged as illustrated.

Reverse

Shift into Reverse only when the vehicle is not moving.

To engage Reverse, move lever to left, press down, move further to left and then push forward. Especially after some driving, depress the clutch pedal fully and rest the shift lever in Neutral for a few seconds before shifting into Reverse.

Back-up lights go on when you engage Reverse gear with ignition on.

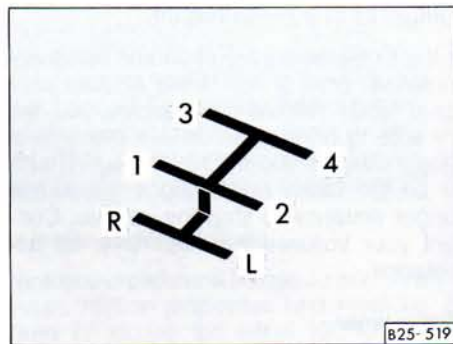

Low-speed traction gear (L) (Syncro models only)

The vehicle is equipped with a four speed manual transmission which has a additional low-speed traction gear (L).

Engaging the Low Gear

Move the gearshift lever as far as possible to the left in neutral, press down and move lever still further to the left and then pull back.

THE DIFFERENTIAL LOCK* (SYNCRO)

When driving around a curve, the outside wheels turn more than the inside wheels. A gear set, part of the transmission, called the differential, compensates for the difference. If, however, one wheel gets on a slippery surface and starts to spin, the differential will not transmit power to the other wheel. The car will be stuck. The differential lock will allow power to be transmitted to both wheels to help get the vehicle moving again. Because the differential is then unable to compensate for cornering, vehicle handling and maneuverability will be reduced. Therefore the differential lock may only be used under limited conditions.

WARNING

Locked differential cannot compensate for cornering and therefore increases tire wear, reduces vehicle maneuverability, driveability and can impair vehicle handling performance. See detailed instructions on next page.

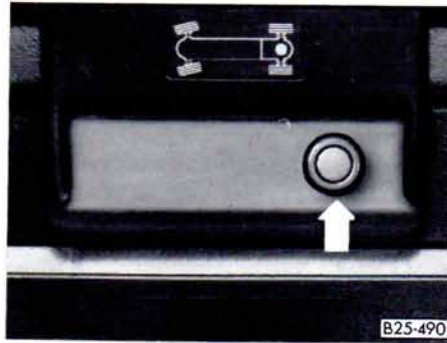

Using the differential lock

Engage or disengage the differential with the knob shown in the center of the instrument panel.

WARNING

To reduce the potential for loss of vehicle control, only use the rear differential lock under the specific and limited circumstances described on the next page.

When the knob is pulled or pushed, engagement or disengagement is only initiated. The actual locking of the differential can be delayed if the wheels are rotating at substantially different speeds. When driving around a corner it could also happen that the lock will not engage or disengage.

Under such conditions slow down and drive in a straight-ahead direction so that the lock may engage or disengage.

The **warning light** above the knob indicates the operational condition of the lock:

- The light comes on only when the lock has engaged properly.
- The light goes out again once the knob has been pushed in and the lock has actually disengaged. If the warning light does not light up, after selecting the differential lock, and after an extended drive, the electrical system and the lock should be checked by your VW dealer.

WARNING

Never lock the differential when...

■ driving on paved roads. When the differential is locked, the rigid connection between the rear wheels has a rubbing effect on the tire when cornering. This leads to increased tires wear and also to “jerking motion” when the vehicle is being steered. The differential lock* for the rear axle must only be used when the vehicle is stuck or is in immediate danger of becoming stuck;

■ one wheel is spinning. First bring the spinning wheel to a standstill, and only then engage the differential. This prevents damage to the drive train or uncontrollable acceleration leading to loss of control and personal injury.

■ The vehicle is being towed – see page 139 also.

■ Testing the vehicle on a dynamometer¹⁾.

See “Driving Tips” on pages 79–84 also.

AUTOMATIC TRANSMISSION*

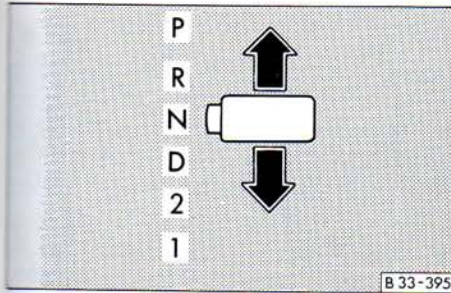

Selector lever positions

WARNING

Apply foot brake when engaging Drive or Reverse.

P – Park

Engage Park only when the vehicle is stationary. Therefore, when parking your vehicle, apply the parking brake first, and then move the selector lever completely to position P. **To do this depress the button in the handle of the selector lever and push it through R to P.** The transmission is then mechanically locked.

Depending on the model, your vehicle may be equipped with an Automatic Shift Lock (ASL). To move the shift lever from the P-Park position to any other position,

*where applicable

you must depress both the **brake pedal** and the button in handle of the selector lever.

Shift out of the Park position, before releasing the parking brake.

When the vehicle is parked on a steep hill, shifting out of Park may be a little harder. This is due to the vehicle's weight exerted on the transmission.

Warning buzzer

A warning buzzer will sound when you open the driver's door with the selector lever left in any other but P-Park position. The warning buzzer will go off as soon as the selector lever is moved to the P-Park position.

R – Reverse

Reverse should be selected only when the vehicle has come to a full stop and the engine is running at idle speed.

Before you move the selector lever to the reverse position you have to depress the push button in the handle of the selector lever.

N – Neutral

Shift to this position for standing with brakes applied.

Depending on the model, your vehicle may be equipped with an Automatic Shift Lock (ASL). To move the shift lever from the N-Neutral position to any other position at speeds below 3 mph (5 km/h) or when the vehicle is stationary, you must depress both the **brake pedal** and the button in handle of the selector lever.

Do not use Neutral for coasting downhill. Coasting downhill with the transmission in Neutral and the engine not operating will result in damage to the Automatic transmission.

D – Normal driving position

Position D is for normal city and highway driving. It ranges from zero to top speed, and all three gears shift automatically, depending on engine load and driving speed.

2 – Position for hilly stretches

This position is to be used for mountain driving or slow driving, and also when you want to make use of the engine's braking effect. In "2", only the first and second gears will engage automatically.

The road speed must not exceed 54 mph or 87 km/h. Therefore, **only shift down into position "2" when vehicle speed is below this speed.** It is not necessary to let up on the accelerator.

1 – Position for steep hills

This position is to be used for mountain driving or slow driving. It also provides for maximum engine braking effect. **To engage this gear depress the push button in the handle of the selector lever first.** In "1" the transmission will stay in first gear and will not upshift.

The road speed must not exceed 33 mph or 53 km/h. Only shift down into "1" when the speed is below this speeds.

WARNING

Do not shift to a lower driving position until vehicle speed has dropped below the specified limits otherwise engine speed will suddenly increase and may cause engine damage and loss of vehicle control.

Driving the automatic transmission

Starting the engine

The selector lever must be in **Neutral** or **Park**. If one of the driving positions is engaged a safety switch will prevent the engine from being started.

Emergency starting

Your Volkswagen with Automatic Transmission cannot be started by pushing or towing. If engine does not start because of discharged battery, the vehicle can be started with jumper cables. Refer to "Emergency starting with jumper cables". Should the engine fail to start consult your nearest Volkswagen dealer.

Selecting a driving position

WARNING

■ **Apply the foot brake before selecting a driving position when the vehicle is stationary.**

When the selector lever is in a driving position, the vehicle may creep even at idle speed. Therefore, do not release the parking brake or foot brake until you are ready to move, because power is transmitted to the wheels as soon as a driving position is engaged.

■ **Do not accelerate while selecting a driving position. At this time the engine must run at idle speed so that no undue stress will be placed on the automatic clutches in the transmission.**

■ **Never have any position engaged when checking in the engine compartment. Make sure the selector lever is securely locked into the P position with the parking brake firmly set. Otherwise, any increase in engine speed may set the vehicle in motion, even with the parking brake applied.**

- **Never shift into Reverse (R) or Park (P) when the vehicle is in motion.**

- **Do not remove the key from the ignition steering lock until you have parked the vehicle, because removal of the key will lock the steering wheel.**

- **If the selector lever is unintentionally moved into Neutral (N) while driving, take your foot off the accelerator pedal and wait until the engine speed has dropped to idling before selecting a driving position.**

Maneuvering

When alternating between forward and reverse – for instance, while maneuvering the vehicle into a tight parking space – only shift when the vehicle has come to a full stop and the engine is running at idle speed.

Stuck in snow, mud or sand

When alternating between forward and reverse in an effort to free the vehicle, depress the accelerator pedal slightly while the transmission is in gear, and release the accelerator pedal while shifting. Do not race the engine and avoid spinning the wheels. **Do not repeat “rocking” back and forth with wheels spinning at high engine speed and heavy throttle, as serious damage may be caused to the automatic transmission and other critical parts.**

Kickdown device

The kickdown device gives maximum acceleration when the accelerator pedal is pressed down past the full throttle position. Depending on road speed and engine speed, either the upshift is delayed (forced throttle) or the box changes down into the next lower gear.

WARNING

Be careful when using the kickdown on slippery roads. Rapid acceleration may cause skidding.

Stopping

- When stopping briefly, at a traffic light for example, it is not necessary to move the selector lever to Neutral. Simply apply the brakes. To start again release brake and accelerate.

- The driving positions must never be used for holding the vehicle at rest uphill. Always use your foot brakes when stopped on inclines.

WARNING

- **Never get out of the driver's seat when the engine is running and the selector lever is not securely locked in the P position.**

- **If you must leave the vehicle move the selector lever securely into the P position and apply parking brake firmly.**

Towing

To tow the vehicle see instructions “Emergency towing” on page 138.

CONTROLS AND EQUIPMENT

STEERING LOCK/IGNITION/STARTER SWITCH

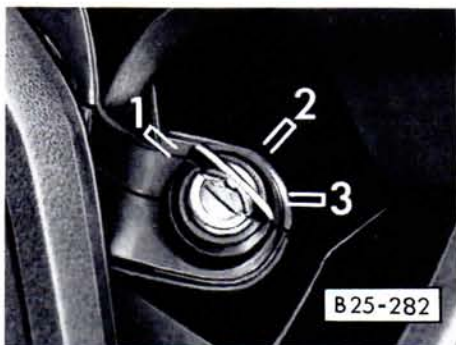

The steering is equipped with an anti-theft ignition lock.

Switch positions

- 1 – Ignition off/steering can be locked.
Pull out the key and turn steering wheel until it locks.

WARNING

■ This position only locks the steering wheel and not the shift control lever. Sudden and unexpected vehicle movement may occur if the shift control lever is moved out of P (Park) (automatic transmission) or out of gear (manual transmission) and the parking brake is not firmly set.

■ Never remove key from steering lock or turn key off while the vehicle is moving. The steering wheel will lock, causing loss of control.

- 2 – Ignition on/steering free.
If it is difficult to turn the key from position 1 to 2, gently move the steering wheel until the key turns freely.

- 3 – Starter engages.
Key returns to Pos. 2 as soon as it is released.
“Starting procedures” see next pages.

In position 3, the power supply to headlights, windshield wipers, blower motor and rear window defogger is temporarily interrupted to conserve battery power.

Before the starter can be operated again the key must be turned back to position 1.

The non-repeat lock in the ignition switch prevents the starter from being operated when engine is running as this could damage the starter.

In position 2 and 3 several warning/indicator lights will come on. Refer to “Warning/indicator lights” for details.

Chime

If you leave the key in the ignition/steering lock, the chime will sound when the driver’s door is opened. This is your reminder to remove the key and lock the doors.

STARTING PROCEDURES

WARNING

- Fasten safety belts before driving.
- Never start or let the engine run in a confined or enclosed, unventilated area. Exhaust fumes from the engine contain carbon monoxide, which is a colorless and odorless gas. Carbon monoxide can be fatal if inhaled.
- Never leave engine idling unattended. An unattended vehicle with a running engine is potentially hazardous.
- Do not park or operate the vehicle in areas where the hot exhaust system may come in contact with dry grass, brush, fuel spill or other material, which can cause a fire.
- Do not leave engine unattended at idle. When starting engine, be ready to drive off immediately. Maintain moderate speed until the engine is completely warm. Remember that your engine performs best at operating temperature.

Automatic Transmission

Engine will only start with selector lever in Neutral or Park.

Manual Transmission

Start with gearshift lever in Neutral, clutch pedal depressed, so that the starter only has to crank the engine.

Starting engine

- Do not depress accelerator pedal when starting. At extrem low temperatures the engine will probably start better, if you depress accelerator pedal slightly.
- As soon as the engine starts, release the ignition key.
- If the engine does not start the first time or stalls, turn the ignition off and restart. Depress the accelerator pedal slowly during the second starting attempt.
- Operate the starter for no more than 10 seconds.
- Allow about 30 seconds between each starting attempt.

STOPPING ENGINE

Do not stop engine immediately after hard or extended driving. Keep engine running for about two minutes to prevent excessive heat build-up.

WARNING

- Before you check anything in the engine compartment, stop the engine and let it cool down. Hot components can burn skin on contact.
- The radiator fan switches on automatically when the coolant reaches a certain temperature and will continue to run (even with ignition off) until the coolant temperature drops.

CONTROLS AND EQUIPMENT

INSTRUMENT CLUSTER

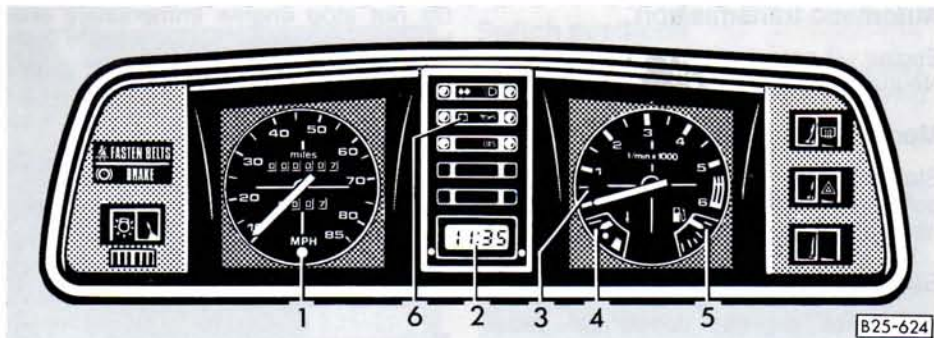

1 – Speedometer/Odometer	page 40
2 – Digital clock*	40
3 – Tachometer* or normal clock	41
4 – Coolant temperature gauge	41
5 – Fuel gauge	42
6 – Warning/indicator lights	

1 – Speedometer/Odometer

The **speedometer** indicates road speed.

The **odometer** indicates the distance driven.

USA models: Miles
Canada models: Kilometers

To record a distance, reset the **trip odometer** to zero by pressing the button. The last digit in red indicates 1/10 of a mile or kilometer.

2 – Digital clock*

To set the digital clock, use a ball point pen.

■ Push left button below display window briefly to advance one hour at a time and right button to advance one minute at a time.

■ Hold buttons depressed to advance hours or minutes rapidly.

■ For second accuracy, synchronize with the aid of a digital wrist watch or a time signal from your radio. Set the clock one minute slow, then briefly push right button the moment the seconds of the wrist watch have completed a full minute or the signal in the radio sounds.

3 – Tachometer*

The red shaded area at the end of the scale indicates the maximum permissible engine rpm (revolutions per minute) for all gears after the break-in period. Before reaching this area, the next higher gear should be selected or the foot eased off the accelerator pedal. Earlier shifting saves fuel and reduces noise.

Shift to the next lower gear when the engine rpm drops below 1500 rpm.

The green shaded area on the scale shows the speed at which the engine is developing its most favourable torque.

3 – Normal clock*

To set the clock, depress the knob in the dial center and turn.

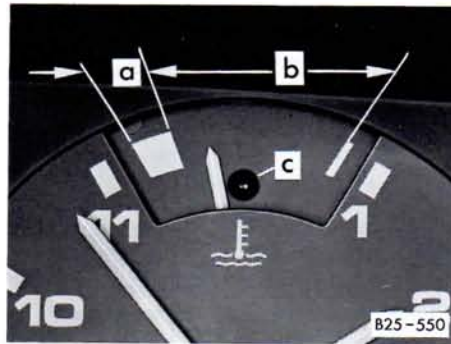

4 – Coolant temperature gauge

The needle in the coolant temperature gauge will indicate the temperature of the coolant shortly after the ignition is switched on.

When ignition is switched on the warning light (c) will flash for a few seconds as a functional check.

a – Engine cold

Avoid high engine speeds and heavy throttle when the needle is still in this area of the dial.

b – Normal temperature

During normal running the needle will remain somewhere in the middle of the dial.

If the engine is working hard at high ambient temperatures, the needle may also go further to the right, **but this is no cause for concern so long as the coolant temperature warning light does not start flashing.**

c – Warning light

If the light flashes when driving first check the coolant temperature gauge. If the needle is in the normal range, add coolant at the next opportunity. If the needle is in the warning range, either the coolant level is too low or the coolant temperature is too high. Move the vehicle a safe distance off the road, stop the engine and depress the emergency flasher switch.

The fan should be operating when the warning light is on (listen for fan, located in front of car behind grille).

WARNING

■ To reduce the risk of being burned, never open the hood if you see or hear steam or coolant escaping from the engine compartment. Wait until no steam or coolant can be seen or heard before carefully opening the hood.

*where applicable

WARNING continued

■ The engine compartment of any motor vehicle is a potentially hazardous area. Before you check anything in the engine compartment, stop the engine and let it cool down. Always exercise extreme caution when working on the engine. Heed all of the WARNINGS on page 97.

Reduce the risk of scalding from hot coolant by following these steps.

■ If the coolant reservoir cap must be removed, wait until the engine has cooled down.

■ Protect face, hands and arms by covering the cap with a large, thick rag to protect against escaping fluid and steam.

■ Carefully and slowly turn cap one turn to allow excess pressure to escape before completely removing cap.

■ To help avoid being burned, do not spill antifreeze or coolant on the exhaust system or hot engine parts. Under some conditions, the ethylene glycol in engine coolant is combustible.

If a visual check shows that coolant level and V-belt are normal, but the warning light continues to flash, contact your nearest dealer to have the cause located and corrected.

For more details see "Cooling system" on page 104.

If the coolant gauge needle nears the upper end of the scale and the engine appears to be overheating, turn off the air conditioner.

Do not install accessories (fog lights or insect screens, for example) on top of the front bumper. They may restrict engine cooling.

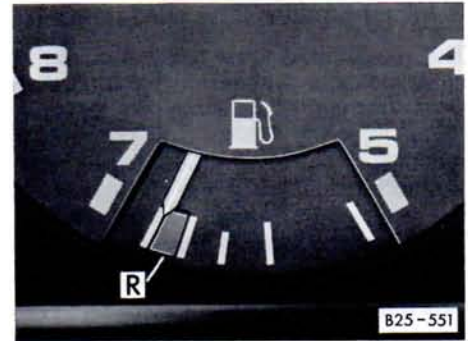

5 – Fuel gauge

The needle in the fuel gauge will indicate the fuel level in the tank shortly after the ignition is switched on.

The fuel tank capacity is 16 gal/60 (syncro 18.5/70) liters.

When the needle reaches the red area at the bottom there is a reserve of about 2.6 U.S. gal. or 10 liters of fuel left in the tank. Time to refuel.

WARNING / INDICATOR LIGHTS

Your vehicle is equipped with several important indicator and warning devices to monitor the continued reliable operation of your vehicle. Familiarize yourself with these devices so if one should come on you know what to do.

Failure to heed applicable warnings and important vehicle information may result in serious personal injury or vehicle damage.

WARNING

■ Whenever stalled or stopped for repair, move the vehicle a safe distance off the road, stop the engine and turn on the emergency flasher (see page 46).

■ The engine compartment of any motor vehicle is a potentially hazardous area. Before you check anything in the engine compartment, stop the engine and let it cool down. Always exercise extreme caution when working under the engine hood. Heed all of the WARNINGS on page 97.

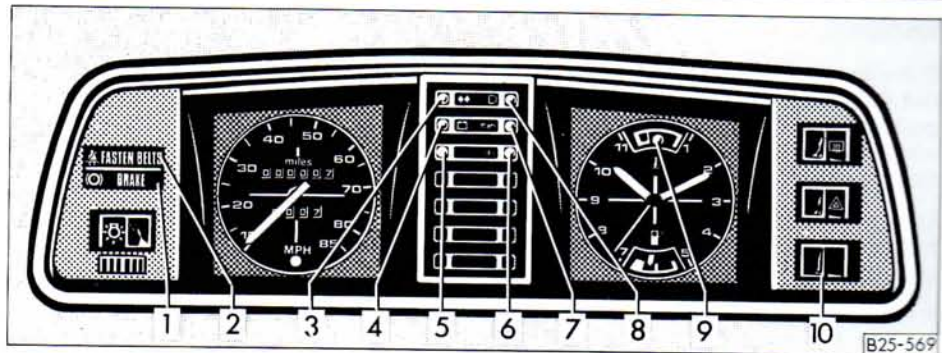

page **1 – Brake**



1 – Brake	43
2 – Safety belt	18
3 – Turn signals	44
4 – Alternator	44
5 – For additional light	
6 – For additional light	
7 – Oil pressure	43
8 – High beam	45
9 – Coolant temperature/level	45
10 – For additional switch	

The light comes on while the engine is cranking. It goes out after the engine is started and the parking brake is fully released. This is your assurance that the brake warning light is functioning properly.

If the brake warning light does not light up while cranking the engine or setting the parking brake, there may be a malfunction in the electrical system. In this case, contact your Volkswagen dealer.

*where applicable

WARNING

If the brake warning light does not go out with the engine running and the parking brake released or lights up while driving, the fluid level in the brake fluid reservoir may be too low.

This might be due to a leak in one of the two independently functioning brake circuits.

If the brake pedal travel has increased, one of the brake circuits may have failed. Avoid driving the vehicle and have it towed to the nearest Volkswagen dealer or qualified workshop for repair.

If brake pedal travel has not increased and braking performance remains unimpaired, proceed carefully to your nearest Volkswagen dealer or qualified workshop to have the braking system inspected and corrected.

For detailed information see "Brakes" on page 29.

2 – Safety belt



Refer to "Safety belts" on page 14 for details.

3 – Turn signals



Refer to "Turn signal/headlight dimmer switch lever" on page 49 for details.

4 – Alternator



This light comes on when the ignition is turned on and goes out after the engine is started. If the light does not go out after starting and revving-up the engine momentarily or lights up while driving, there may be a malfunction in the electrical system or the V-belt to the alternator may be loose or broken.

In this case, **turn the engine off** and contact your Volkswagen dealer.

5 – For additional light

6 – For additional light

7 – Engine Oil pressure



When the ignition is turned on, the oil pressure warning light comes on for a bulb check. It should go out after the engine has started.

If the warning light does not go out or flashes while driving (above 2000 engine rpm a buzzer will sound simultaneously), it indicates, that the oil pressure is too low.

Stop the engine immediately, check the engine oil level and add oil, if necessary.

If engine oil level is normal, but the light continues to flash, do not continue to operate the vehicle. This could damage the engine.

Turn the engine off and contact the nearest Volkswagen dealer for assistance.

The oil pressure warning light is not an indicator for low engine oil level. To check the oil level, always use dipstick (see page 99).

Make it a habit to have the engine oil level checked with every fuel filling.

8 – High beam



Refer to “Turn signal/headlight dimmer switch lever” on page 49 for details.

The indicator light lights up when the high beams are switched on or when the headlight flasher is used.

9 – Coolant temperature



Refer to “Coolant temperature gauge” on page 41 for details.

CONTROLS AND EQUIPMENT

SWITCHES

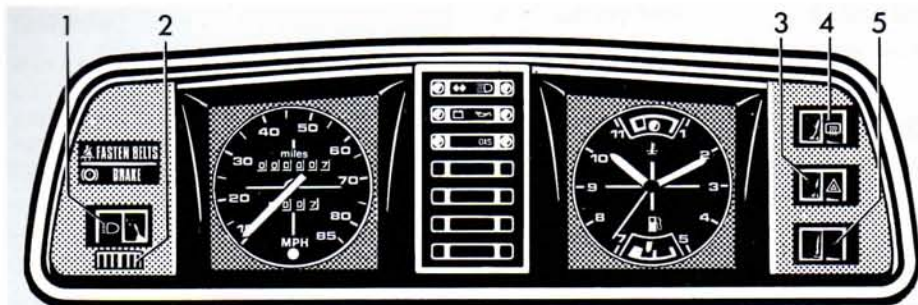

B25-286

1 – Lights	46
2 – Instrument illumination	46
3 – Emergency flasher	46
4 – Rear window defogger	47
5 – For additional switch	

page 1 – Lights



Depress the rocker switch to the first stop to turn on the parking, side marker, license plate, tail and instrument panel lights. Depress the switch to the second stop to turn on the headlights (ignition on). To conserve battery power, the headlights will go out automatically when the ignition is turned off or when the engine is started.

Headlight dimmer and headlight flasher see page 48.

2 – Instrument illumination

Turn the thumb wheel below rocker switch to adjust the brightness of instrument lights.

3 – Emergency flasher



The emergency flasher works independently of the ignition switch position.

If your vehicle is disabled or parked under emergency conditions, depress the switch to make all four turn signals flash simultaneously. The warning light in the rocker switch flashes, too.

WARNING

Move the vehicle a safe distance off the road when stalled or stopped for repairs. Do not park or operate the vehicle in areas where the hot exhaust system may come in contact with dry grass, brush, fuel spill or other material which can cause a fire.

4 – Rear window defogger*



The rear window defogger works only with the ignition on.

The rear window defogger – together with the flow through ventilation – will help to keep the inside of the rear window clear of condensation and frost.

The rear window defogger is not designed for melting snow. Therefore, always remove heavy snow and ice accumulations before driving off.

Depress the switch to turn on the rear window defogger.

The control light in the switch will light up to remind you that the defogger is switched on. After the rear window has been cleared, switch off the rear window defogger to avoid unnecessary drain on the battery.

By saving electricity, you save fuel. See also page 72.

When the rear window defogger is switched on, the outside mirrors with electric remote control* are electrically heated at the same time (see page 13).



Electrically heated seat*

With ignition on, the backrest and seat cushion of the driver's seat can be heated electrically.

The heating element can be regulated and turned on and off with the thumbwheel switch behind the steering wheel.

* where applicable

CONTROLS AND EQUIPMENT

TURN SIGNAL / HEADLIGHT DIMMER SWITCH LEVER



Turn signals

The turn signal indicator light flashes when you operate the lever (ignition on).

Lever up – right turn signal
Lever down – left turn signal

The turn signals are cancelled automatically when you have completed a turn (for example when turning a corner), and the steering wheel returns to the straight-ahead position.

If a signal fails, the indicator light flashes about twice as fast. A light bulb may have to be replaced.

Lane changer

Move the lever up or down just to the point of resistance – the indicator light must also flash at the same time. The lever will return to the OFF position when released. The lever will return to the OFF position when released.

Headlight dimmer

With headlights on (light switch in second stop), you can switch to either high or low beam by pulling the lever toward the steering wheel past the point of resistance. When high beam is on, the indicator light will light up.

Headlight flasher

With headlights on or off, you can signal with your headlights (in lieu of horn), by repeatedly pulling the lever just up to the point of resistance.

CRUISE CONTROL*

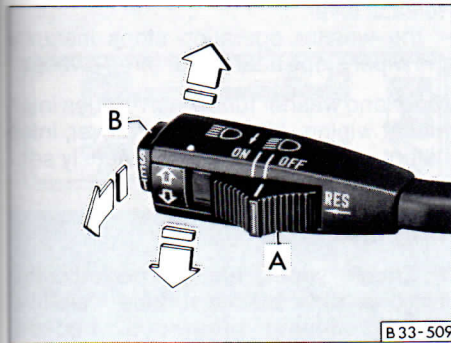

The cruise control allows you to maintain a constant cruising speed above 22 mph (35 km/h), without actuating the accelerator pedal.

Any manual operation, such as accelerating, gearshifting or braking can be done independently of the cruise control.

The cruise control is operated with sliding button A and pressure button B positioned at the end of the turn signal/headlight dimmer switch lever.

WARNING

■ To help keep the vehicle under control do not use the cruise control when driving on winding or slippery roads, in heavy or in varying traffic.

■ Do not use the Resume feature when the previously set speed is too fast for the existing traffic conditions.

Sliding button A to position ON actuates the cruise control system.

Accelerate to the desired speed and depress button B (SET). This sets the cruising speed and stores it in a memory. The foot can then be taken off the accelerator pedal.

With button B, the programmed speed can also be increased. When the button is depressed, the vehicle accelerates until the knob is released.

If you accelerate – for example when passing – the previously programmed speed will be resumed automatically after the accelerator pedal is released.

When the cruise control is switched on, do not shift into Neutral without de-clutching! The engine will rev up immediately and may possibly be damaged.

The cruise control is temporarily disengaged when brake or clutch pedal is depressed or when the road speed drops considerably below programmed speed, for example when driving uphill.

To re-engage the system, slide button A to RES (Resume) and the vehicle will automatically accelerate to the previously programmed speed.

A programmed speed can be completely erased from the memory of the cruise control system by sliding button A to the OFF position. A programmed speed is always erased when the ignition is switched off.

WARNING

Do not remove key from steering lock, while you are driving or while the vehicle is rolling to a stop. The steering wheel will lock when you remove the key, and you will not be able to steer the vehicle.

*where applicable

CONTROLS AND EQUIPMENT

WIPER AND WASHER SYSTEM

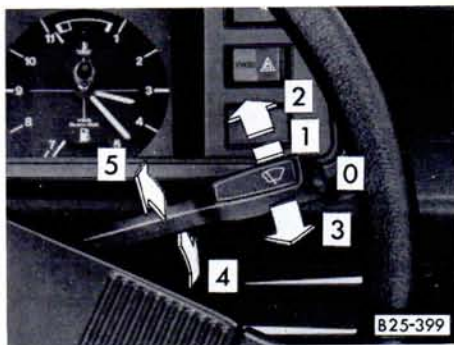

The wiper and washer systems only work when the ignition is on.

Always loosen blades frozen to glass before operating wipers to prevent damage to the wiping system.

Windshield

Brief wiping

Lift lever to pressure point before position 1.

Low wiper speed:

Lever in position 1.

High wiper speed:

Lever in position 2.

Intermittent wiping:

Lever in position 3.

The wipers operate about once every six seconds.

Automatic wiper/washer:

Pull lever towards steering wheel (position 5) and hold – wipers and washer work.

Release lever – washer stops and the wipers carry on for about four seconds.

Rear window*

Push lever to position 4 and release – the wiper will operate approx. every six seconds (intermittent wiping).

Push lever again to position 4 and release. The wiper stops.

Automatic wiper/washer:

Push lever to position 4 and hold – both, wiper and washer will operate.

Release lever

– the washer operation stops instantly and wiper stops after two or three sweeps.

Wiper and washer function overrides intermittent wiping. After releasing lever, intermittent wiping continues if previously set.

WARNING

■ Check wiper blades periodically. Worn or dirty blades reduce visibility, making driving hazardous. Loosen blades frozen to glass before operating wipers.

■ Clean all windows, windshield and wiper blades regularly to remove road film and carwash wax buildup. Use an alcohol base cleaning solution and a sponge or soft cloth. Dry glass with a chamois.

■ Do not use the wiper/washer in freezing weather without first warming the windshield with the defrosters, otherwise the washer solution may freeze on the windshield and obscure your vision.

■ Avoid running the wiper blades over a dry windshield to prevent scratching the glass. A scratched windshield will reduce visibility.

*where applicable

VENTILATION / HEATING

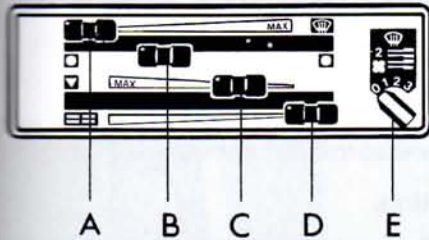

B25-568

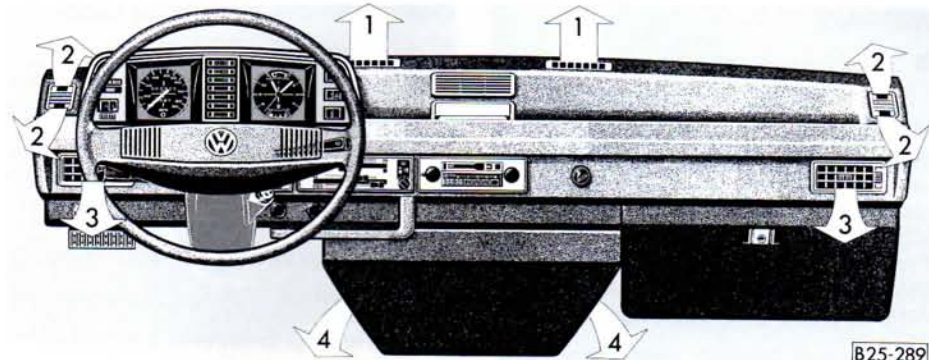

B25-289

Operating Controls

Levers A and C – Air distribution

Lever A at right – windshield (1) and side window (2) outlets open.

Lever C at left – footwell outlets under dashboard (4) and footwell outlets in passenger compartment* open.

Lever B – Temperature control

To increase heat – slide lever to right.

To decrease heat – slide lever to left.

Lever D – Roof outlets in passenger compartment*

To increase outside air flow – slide lever to left.

To decrease outside air flow – slide lever to right.

Fan control switch E

The air column can be regulated with three fan speed settings.

Air outlets/vents

Heater or outside air flow from outlets 1, 2, 3, 4 and footwell outlets in passenger compartment*, according to control lever positions.

Outside air flow from roof outlets in passenger compartment*.

The side dashboard outlets 3 are individually adjustable –

side lever down – vent open

side lever up – vent closed.

Adjust air flow direction sideways or up and down with center lever.

WARNINGS see next page.

*where applicable

WARNING

- Good visibility comes with windows free of fog, condensation and frost.
- For clear visibility and safe driving it is extremely important that you thoroughly familiarize yourself with and follow the operating instructions pertaining to the proper use and function of the ventilation/heating and defogging/defrosting system in this manual. If in doubt, consult your Volkswagen dealer.
- Maximum heating output and fast defrosting can be obtained only after the engine has reached operating temperature.

Defogging and defrosting windshield and side windows

- Slide all control levers to the extreme right and turn fan control switch E to speed setting 2.
- The fan control switch for the secondary heat exchanger should be OFF.

Warming up vehicle interior quickly

- Slide levers A, B and D to extreme right.
- Slide lever C to extreme left.
- Open air outlets 3.
- Turn fan control switch E to speed setting 2.

Warming up vehicle interior normally

Once the windshield and side windows are clear and the vehicle interior is warm, you may want to set the controls as follows:

- Slide lever A to the left.
- Slide lever B to desired temperature setting.

- Slide lever C toward center.

- Turn fan control switch E to speed setting 1.

Outside air ventilation

With lever B at extreme left, outside air is emitted from all open outlets.

Hints

- All operating controls, except fan control switch E and fan control switch for the secondary heat exchanger can be adjusted to any intermediate position.
- Stale air is drawn out of the vehicle interior through vents on the inside front door panels. The vents can be opened or closed by sliding the lever forward or rearward.



B25-419

Secondary heat exchanger for passenger compartment*

This heat exchanger is located under the rear seat bench. The air volume can be regulated with the 3-speed fan control switch on the instrument panel (see above illustration).

During the warm months of the year, the secondary heat exchanger can supplement the outside air flow-through ventilation system.

To prevent warm air flow from reaching the footwells, the heat exchanger valve must be shut off.

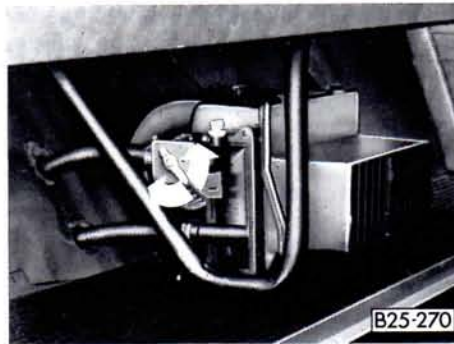

B25-270

To gain access to the valve –

- Grasp upper edge of kick panel under rear seat bench and pull out.
- To open valve – pull lever forward.
- To close valve – pull lever rearward (see above illustration).
- Reinstall kick panel securely.

CONTROLS AND EQUIPMENT

AIR CONDITIONER*

WARNING

- Good visibility comes with windows free of fog, condensation and frost.
- For clear visibility and safe driving it is extremely important that you thoroughly familiarize yourself with and follow the operating instructions pertaining to the proper use and function of the ventilation/heating, defogging/defrosting and air conditioning system in this manual. If in doubt, consult your Volkswagen dealer.

The air conditioning unit is installed under the roof of the driver's cab. Ten air outlets permit interior cooling throughout the vehicle.

Two climate control switches are located on the instrument panel.

The unit operates on the air recirculation principle. Air is sucked in through the two large air intake grilles at the rear portion of the unit.

Because the air conditioner is not normally used at low ambient temperatures it is designed to operate only when outside temperature is above 41° F or + 5° C.

When the air conditioner is on, temperature as well as humidity inside the vehicle is controlled. During high outside humidity you can prevent windshield and windows from fogging by setting the controls accordingly.

Maximum cooling is maintained with standard heating/ventilation controls turned off and the windows closed.

However, when the vehicle interior is very hot from standing in the sun, open a window for a few minutes to permit hot air to escape.

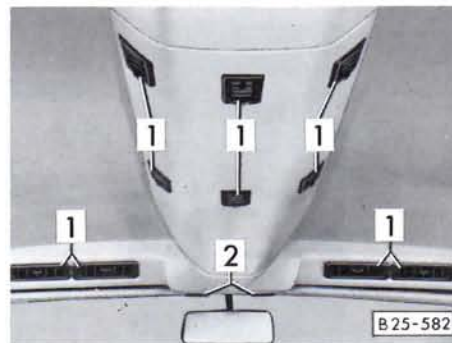

Air outlets/Vents

- 1 – These air vents can be adjusted or closed completely.
 - Tilt air vent housing to direct air flow up or down.
 - Turn thumb wheel to direct air flow sideways.
 - To open outlets, position thumb wheel in center of vents.
 - To close air outlets, turn thumb wheel to extreme right or left.
- 2 – These air vents can be adjusted but not closed.
 - Direct air flow by swiveling the vent housing.

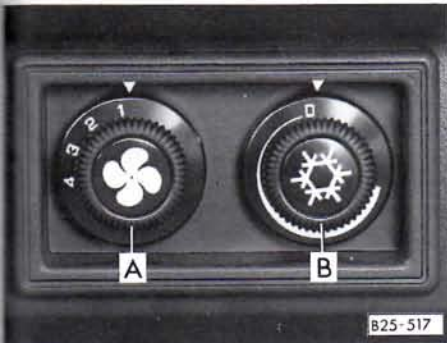

Operating controls

A – Fan switch

- Adjust air volume by turning switch knob or either one of the three speeds.
- With fan switch knob OFF, the air conditioner will not operate.

B – Temperature control switch

- Turn switch knob right for cooler air.
- Turn switch knob left for warmer air.

Operating hints

Comfort cooling

- Turn fan switch A to speed setting “1” or “2”.
- Turn temperature control switch B to desired position.
- Adjust air outlet vents as desired.

Maximum cooling

- Turn fan switch A to extreme right.
- Turn temperature control switch to extreme right.
- Adjust air outlet vents as desired.

Malfunctions

If the unit does not operate

- Outside temperatures may be below 41° F or + 5° C.
- The air conditioner fuse may have blown. Turn the unit off and check fuse. See page 129 for use panel location.

General hints

If water drips under the vehicle

When outside temperature is high and the air very humid, condensed water can drip off the evaporator under the vehicle. This is normal and does not indicate a leak.

Payload reduction

The weight of the air conditioner installed in your vehicle reduces the vehicle's load carrying capacity. For weight information, see sticker on left doorjamb.

Maintenance

The condenser should be checked periodically for cleanliness. If clogged with dirt or insects, the condenser should be washed down with water.

After the winter months and before extended summer usage, the air conditioner should be checked and, if necessary, serviced by your Volkswagen dealer.

AUXILIARY HEATER*

Turn the auxiliary heater on and off with the temperature switch, located on the right of the steering column. Use the same switch to regulate the heat.

Depending on vehicle model, the warm air flows from the footwell vents for the passenger compartment and/or from a controllable vent under the driving seat. The air distribution cannot be controlled.

While driving, the heater can be operated continuously. When the engine is not running, the heater will shut off automatically after 10 minutes to save battery power.

The auxiliary heater is running on fuel from your fuel tank. Fuel consumption varies according to operating conditions and heat output (approx. 1 US qt or one liter per hour).



Switch knob positions

- 0 – Heater off.
- 0–1 – Heater on (engine stationary)
- 2 – Heater on (engine running)
- 2–3 – Temperature adjustment range.

Engine stationary/ignition off

Heater on:
From position 0, push knob in and turn clockwise. Switch knob control light will come on. Knob will spring back out when released. Adjust temperature by turning knob between positions 2 and 3.

Heater off:
The clockwork in the temperature regulating switch switches the heater off automatically after about 10 minutes and the lamp goes out.

To switch off before clockwork has run down:

Turn temperature regulating switch anticlockwise to 0. The lamp goes out and clockwork runs down.

*where applicable

Engine running

Heater on –

Turn knob clockwise to position 2. Switch knob control light will come on. Adjust temperature by turning knob between positions 2 and 3.

Heater off –

Turn switch knob counter-clockwise to position 0. Switch knob control light will go out.

Notes

■ Every time the heater is switched off, the warm air and combustion air blowers continue running briefly to cool the heater down quicker.

■ To avoid draining the battery, do not run the heater repeatedly when the engine is not running.

■ When the heater is running on the clockwork time switch, it must be switched off by hand before attempting to start the engine at low temperatures so that the full battery capacity is available to turn the engine.

WARNING

Never start the heater or let the engine or the heater run in an enclosed, un-ventilated area. Exhaust fumes from the engine or the heater contain carbon monoxide, which is colorless and odorless. Carbon monoxide, however is a very harmful gas, and may be fatal if inhaled.

Due to the risk of fire the heater must not be used when vehicle is parked on dry grass, brush or leaves.

Maintenance

During the winter and when driving over very poor roads, mud or snow may tend to accumulate in the exhaust and combustion air intake pipes. Have these pipes checked for blockage from time to time so that the heater can continue to work.

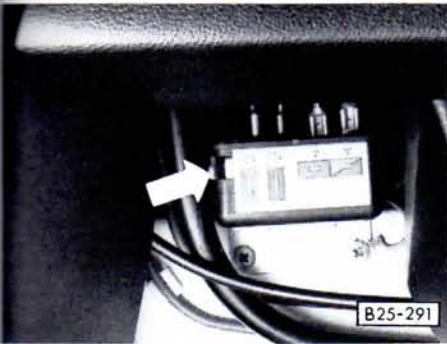

Fuses

The auxiliary heater is equipped with two fuses, one 16 amp fuse for the entire heater and one 8 amp fuse for the overheating switch. Both fuses are located in a fuse holder behind the fuse panel on the left side under the dashboard. When the fuse for the overheating switch is blown, the fan is working however no heat is delivered.

If the replacement fuse blows again, have the heater checked by your Volkswagen dealer.

The heater has a safety switch which is located under the dash on the left near the steering column. If the heater does not start, or starts and then stops again, wait 3 minutes and then operate the red lever on the safety switch.

If the heater still does not work or if the safety switch stops it again, there is a defect in the heater which can only be repaired by a Volkswagen workshop.

CONTROLS AND EQUIPMENT

AUXILIARY HEATER* (Syncro models only)

The auxiliary heater* heats the coolant in the heating circuit and supplies the heat exchanger in the normal heating system and the additional heat exchanger* for the passenger compartment heating with heated coolant.

The system is switched off and on or the switch- on time preselected by means of a switch and indicator unit located on the left under the instrument panel.

Air distribution and regulation is done with the controls of the normal heating and ventilation system (see "Ventilation/Heating" on page 51).

The auxiliary heater can be used with vehicle stationary or when it is moving. When vehicle is stationary, the heater only runs for a maximum of 30 minutes in order to avoid draining the battery. It also switches off automatically when a coolant temperature of 80° C (175° F) is reached.

When the coolant temperature drops below 70° C (158° F) the heater is automatically switched on again.

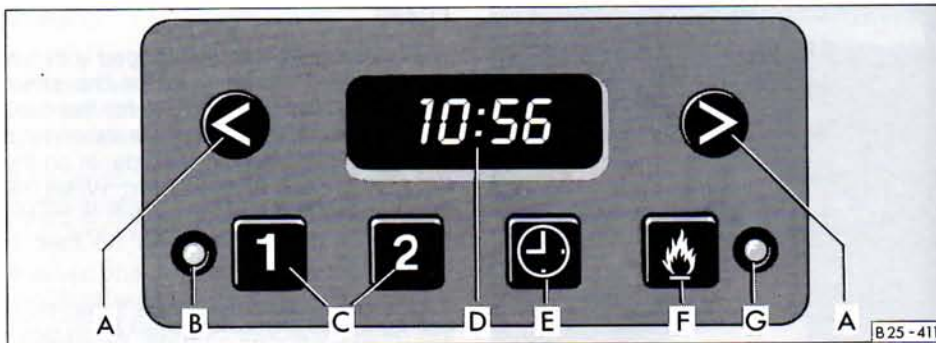

The heater runs on fuel from the vehicle tank and uses up to half a litre (one quart) per hour.

Controls

- A – Buttons for setting time and preselected time
- B – Indicator lamp for preselected time
- C – Preselected time
- D – Display
- E – Actual time
- F – Heater on/off
- G – Warning lamp (Heater on)

Setting the time

- Press and hold clock button E.
- Set clock with buttons A.

The display lights up as long as button is pressed. When button is released the display goes out or, if a time has been pre-selected, the selected time lights up for 2 secs.

To switch heater on or off

- This is done by pressing button F. When heater is switched on the warning lamp G lights up.

To ensure that the heater starts the lever for the heat output must be pushed fully to the right. This closes an electrical contact.

Preselecting starting time for heater (stationary operation, ignition off)

With buttons C two different switch-on times can be selected within 24 hours.

- Press and hold button. The appropriate figure 1 or 2 appears in display. The ready-for-action lamp lights up.

- Set required switch-on time with buttons A. The display remains on for about 20 seconds after releasing button C.

To ensure that the heater starts up at the selected time, the lever for the heat output must be pushed fully over to the right. In addition to this the blower must be switched to Stage 1. On account of the higher current consumption, a higher stage should only be selected in isolated cases.

Switching preselected time off

- The preselected time can be switched off by briefly pressing the appropriate button C. The ready-for-action lamp and the figure in display then go out.

Fuses

The fuses for the auxiliary heater are in an additional holder behind the main fuse box.

Notes

- Every time the heater is switched off, the warm air and combustion air blowers continue running briefly to cool the heater down quicker.
- To avoid draining the battery, do not run the heater repeatedly when the engine is not running.
- When driving through mud and snow, the exhaust pipe may tend to get blocked. Have a look at it occasionally to see that it is clear.

WARNING

Never start the heater or let the engine or the heater run in an enclosed, unventilated area. Exhaust fumes from the engine or the heater contain carbon monoxide, which is colorless and odorless. Carbon monoxide, however is a very harmful gas, and may be fatal if inhaled.

Due to the risk of fire the heater must not be used when vehicle is parked on dry grass, brush or leaves.

CONTROLS AND EQUIPMENT

SLIDING ROOF*



To open pull crank handle out of recess and turn counter-clockwise.

To close turn crank handle clockwise.

The sliding roof is locked in any position.

WARNING

To reduce the risk of personal injury in an accident or sudden stop, always fold the handle back into its recess after use.

Note:

If the roof is difficult to move after a while, clean and lubricate the guide rails. See page 92.

SUN ROOF*

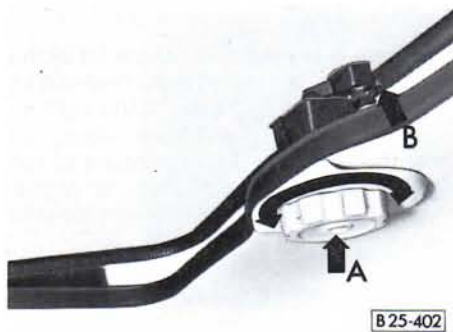

The roof is opened and closed with the knurled disc in the headlining above the front seats.

The roof can be tilted at the rear as desired or taken out altogether.

Raising

Turn knurled disc clockwise.

Lowering

Turn knurled disc anti-clockwise.

To take out

- Turn retaining screw (A) in centre of knurled disc one quarter turn clockwise (e.g. with a coin) with roof closed.
- Then raise roof and press it up.
- Press locking lever (B) up.
- Detach roof.
- Lift roof from outside and pull it out to the rear.

To put back

- Slide roof back into the hinges and let it drop lightly into the retainers.

WARNING

Ensure that the roof is properly inserted into the two retaining hinges at the front, and locked at the rear. The roof must only be unlocked when vehicle is stationary.

INTERIOR LIGHTS

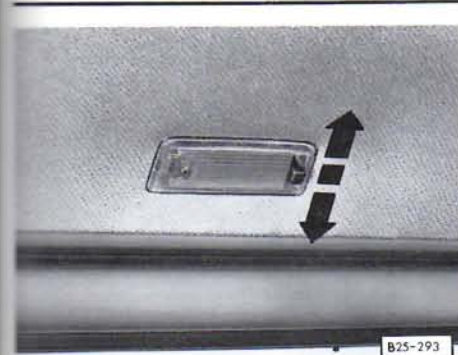

Switch positions

Front interior light:

- Up -ON- with doors open
- Center -OFF
- Down -ON- with doors closed

Rear interior light:

- Up/front -ON- with doors open
- Center -OFF
- Down/rear -ON- with doors closed

Reading light on the dashboard

- Up -Off
- Down -On

CIGARETTE LIGHTER



- Push knob in.

When lighter is ready for use, it will spring back.

The socket of the cigarette lighter may be used for 12 volt appliances with maximum consumption of up to 100 watts, such as hand spot light, small vacuum cleaner, etc.

WARNING

Cigarette lighter and socket remain functional even after the ignition key is removed. Therefore, never leave children inside the vehicle without supervision.

CONTROLS AND EQUIPMENT

ASHTRAYS



To **remove** ashtray from **dashboard**, grip the strip on opened lid and lift at one side to take out.

To **replace**, move ashtray lid to closed position and press into housing.



To **remove passenger compartment** ashtray, open tray, press down and pull out.

To **replace**, first insert upper edge, and then slide ashtray all the way into housing.

WARNING

Never use ashtrays as waste paper receptacles fire hazard!

GLOVE COMPARTMENT



To open

– Squeeze the two lock latches together

To close

– Press door upward until lock engages

To lock or unlock *

– Turn key B to right or left

WARNING

To reduce the risk of personal injury in an accident or sudden stop, keep glove compartment closed while driving.

*where applicable

FOLDING TABLE*

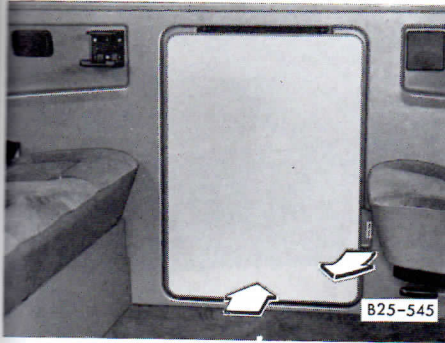

Folding the table up

To release the table from its locked position, push against the lower part of the tabletop.

Swing the table upwards until it locks into its horizontal position.

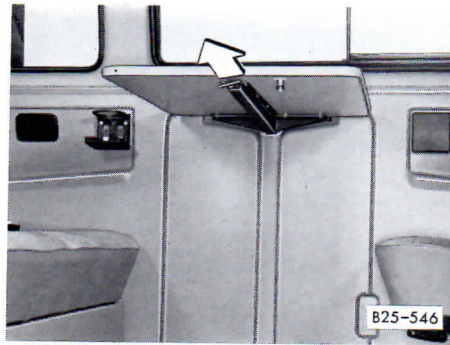

Folding the table down

Pull the release lever and swing the table top down (see illustration).

To secure the table top, push it against the side panel until it locks into place.

WARNING

- The table top release does not have a locking device, therefore take care not to unintentionally fold down the table.
- To prevent personal injury, the table top must be folded down and locked into place while driving.

CONTROLS AND EQUIPMENT

FLUORESCENT LAMP*

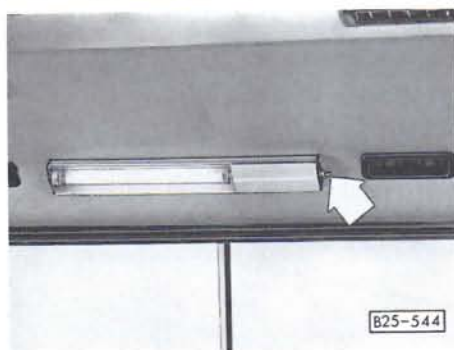

The switch found beside the fluorescent lamp is used to switch the lamp on and off.

Caution

To save battery power, do not leave the fluorescent light switched on when the vehicle is unattended.

CUP HOLDER*



The cup holders in the passengers compartment should always be folded up when not in use. Fold the upper part up and the lower part downwards.

SUN VISORS



You can lift the visor on the driver's side out of the center mounting and move it toward the door window to protect against side glare.

VANITY MIRROR*

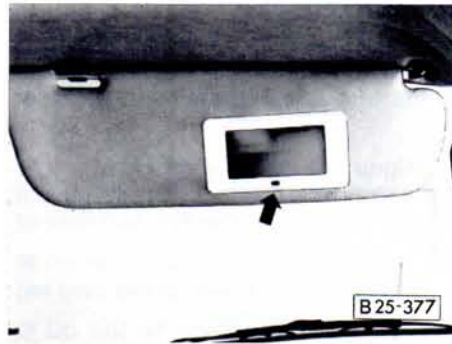

A **vanity mirror** is located on the back of the sun visor on the passenger's side.

To illuminate the vanity mirror, slide the switch (arrow).

When the sun visor is tilted up, illumination is shut off automatically.

ASSIST HANDLES/COAT HOOKS*

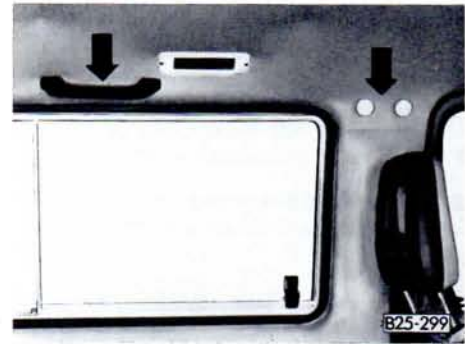

Assist handles and coat hooks are intended for your convenience.

WARNING

- Hang clothes in such a way that they do not impair the driver's vision.
- Do not hang heavy objects on the coat hooks, as they could cause personal injury in the event of a sudden stop.

*where applicable

CONTROLS AND EQUIPMENT

ROOF RACK

If a roof rack should be installed, note the following:

- Use only roof racks which attach to the rain gutters.
- Always distribute loads evenly.
- Never exceed the vehicle's total load carrying capacity. See page 150 for details.
- When transporting maximum permissible loads, large or bulky items, or long, flat shaped objects, bear in mind that they will influence the vehicle's aerodynamics, center of gravity and overall handling. To counterbalance these influences, adjust steering habits and driving speed accordingly.
- When the roof rack is not in use, remove the roof rack to reduce wind noise, improve on fuel consumption and to guard against theft.

BREAK-

During the engine's later when broken in is done on the way first 900

For the (1000 k

- Do not
- Do not speed.
- Avoid

From 6 (1000 t

The speed the maximum speed.

After b

The maximum is 5200 Shift in ing the the tac

Excess cally re

BREAK-IN PERIOD

During the first few operating hours, the engine's internal friction is higher than later when all the moving parts have been broken in. How well this break-in process is done depends to a considerable extent on the way the vehicle is driven during the first 900 miles (1500 kilometers).

For the first 600 miles (1000 kilometers):

- Do not use full throttle.
- Do not drive faster than $\frac{3}{4}$ of top speed.
- Avoid high engine speeds.

From 600 to 900 miles (1000 to 1500 kilometers):

The speed can gradually be increased to the maximum road speed or engine speed.

After break-in period

The maximum permissible engine speed is 5200 rpm and should not be exceeded. Shift into the higher gear before reaching the red area at the end of the scale of the tachometer. See page 41.

Excessive engine speeds are automatically reduced.

DURING AND AFTER BREAK-IN PERIOD

■ Details on how to operate the Manual and Automatic transmission are outlined in the "Controls and equipment" chapter.

■ **Avoid full throttle starts and abrupt stops.**

■ **Try to avoid running the engine at maximum speed. Shifting up early helps to save fuel and reduces noise.**

■ **Do not overstrain engine; select proper gear before reaching top speeds.**

■ **Do not let engine labor. Shift down when engine no longer runs smoothly.**

■ **All revs are only valid when engine is properly warm.**

■ **Always observe local and national speed limits.**

Applies in addition to vehicles with Automatic Transmission:

Make it a habit to accelerate gradually instead of using full throttle. During gradual acceleration the transmission shifts earlier into the next higher gear thus saving fuel.

WARNING

■ **New tires do not possess maximum traction. They tend to be slippery. Break new tires in by driving cautiously at moderate speed for the first 100 miles (160 kilometers).**

■ **New brake pads and linings do not have optimum friction properties and must be "broken in" during the initial 100 to 150 miles (150 to 200 kilometers) of normal city driving. You can compensate for this by applying more pressure on the brake pedal. This also applies later when new pads or linings are installed.**

VEHICLE OPERATION

OPERATE YOUR VEHICLE SAFELY

A lot has gone into the manufacture of your Volkswagen, including advanced engineering techniques, rigid quality control and demanding inspections. These engineering and safety features will be enhanced by you, the safe driver,

- who knows the vehicle and all controls
- who maintains the vehicle properly
- who uses driving skills wisely.

For your own safety as well as that of those around you – be a responsible driver. **If you drink, do not drive.** The use of alcohol, drugs and certain medications will seriously impair perception, reactions and driving ability, substantially increasing the risk of an accident and personal injury. **Do not drive if you are tired, ill or under emotional stress.**

The following points are also important for your safety, please observe them all.

First things first . . .

- Turn the engine off before performing any checks or repairs on the vehicle.
- Be sure tires are inflated correctly. Check for damage and tire wear.
- See that wheel bolts or nuts are properly tightened and not loose or missing.
- Check engine oil level, add if necessary. Make it a habit to have engine oil checked with every fuel filling.
- Check coolant level to assure sufficient engine cooling.
- Be sure you have a well charged battery.
- Check brake fluid level. If too low, have brake system checked.
- Replenish windshield washer fluid.
- Replace worn or cracked wiper blades.
- See that all windows are clear and unobstructed.
- Check whether all light lenses are clean.

- Be sure all lights are working and headlights are aimed correctly.

- Check under vehicle for leaks.

- Make sure the movement of either brake, clutch or accelerator pedal is not hampered in any way.

- Be sure all luggage is stored securely.

You'll find helpful hints on how to perform most of these checks in this manual. If in doubt, have these checks performed by your dealer or any other qualified mechanic.

Emergency equipment

It is good practice to carry emergency equipment in your vehicle. Some of the things you should have are: emergency light, first-aid kit, small shovel, and for the winter season, an ice scraper, snow brush, a container or bag of sand or salt, etc.

In the driver's seat

- Check operation of horn.
- Adjust seat for easy reach of controls.
- Adjust head restraints to your size.
- Adjust inside and outside rear view mirrors.
- Use safety belts as directed.
- Assure yourself that all passengers, especially children, are properly buckled up.
- Check operation of foot and parking brakes.
- Check all warning and indicator lights when starting the engine.
- Do not leave vehicle idling unattended.
- Lock all doors from inside to prevent inadvertent opening of doors from inside and unwanted entry from outside.

On the road

- Always drive defensively. Expect the unexpected.
- Observe speed limits and obey road signs.
- Use signals to indicate turns and lane changes.
- Turn on headlights at dusk.
- Always keep a safe distance from the vehicle in front of you, depending on traffic, road and weather conditions.
- Reduce speed at night and during inclement weather.
- If you smell gas fumes in the vehicle, drive with the windows open, but keep the rear lid closed. Have the cause immediately located and corrected.
- Make frequent rest stops, at least after every two hours of driving.
- When tired pull off the road, stop and take a rest. Turn the engine off. Do not sit in the vehicle with engine idling. Engine exhaust is dangerous if inhaled.

■ When stopped or parked, always set the parking brake. Move the selector lever to "P" (Automatic transmission) or move the gearshift lever to reverse or first gear (Manual transmission). When parking on hills, turn wheels toward the curb.

■ When stalled or stopped for repairs, move the vehicle well off the road. Turn on emergency flasher and use other warning devices to alert other motorists. Do not park or operate the vehicle in areas where the hot exhaust system may come in contact with dry grass, brush, fuel spill or other material which can cause a fire.

■ Make it a habit to have the engine oil checked with every fuel filling.

VEHICLE OPERATION

OPERATE YOUR VEHICLE ECONOMICALLY AND MINIMIZE POLLUTION

Your personal style of driving determines your operating costs, **exhaust emissions** and **noise levels**. To obtain the best possible fuel economy, **minimize pollution** and save wear and tear on the engine, brakes and tires, observe the following points:

- Keep a light foot on the accelerator.
- Drive smoothly, avoid abrupt changes in speed as much as possible.
- Avoid jack rabbit starts and sudden stops.
- Avoid unnecessary idling. Turn the engine off.
- "Warm up" idling wastes gas. Start the engine just before you are ready to drive. Accelerate slowly and smoothly.
- Do not drive longer than necessary in the lower gears. By upshifting early you can economize on fuel consumption.

■ Organize your trips to include in several errands.

■ Any additional weight carried in the vehicle reduces fuel economy. Always keep cargo to a minimum and remove all unnecessary items.

■ Remove roof and ski racks when not in use.

■ All electrical consumers contribute to increased fuel consumption. Therefore, use fan, rear window defogger, etc., only when needed.

■ Check your vehicle's fuel consumption regularly. Keep a written tally sheet or use the trip odometer. Fuel consumption will vary with traffic, road and weather conditions.

■ Have your vehicle serviced by an Volkswagen dealer at the specified intervals (see page 95 and your Maintenance brochure).

■ Air cleaner should be inspected to assure proper engine "breathing".

■ Battery should be fully charged.

■ Wheels should be properly aligned.

■ Tires should be inflated to correct pressures. Check tire pressures regularly – at least once a month.

■ **The published ENVIRONMENTAL-PROTECTION AGENCY (EPA) and Transport Canada mileage estimates may not agree with your actual highway mileage which will vary, depending upon vehicle load and speed, road and weather conditions, trip length, etc.**

■ Have the engine oil level checked with every fuel filling. Engine oil consumption is normal but tends to be higher when the engine is new. The use of quality engine oil and a correct engine oil level are essential for vehicle performance and economical operation at all times.

TRAILER TOWING

Your Volkswagen was primarily designed for passenger transportation. If you plan to tow a trailer you should be mindful that your car will be performing a service it was not intended for. The additional load will affect durability and economy of performance.

If you tow a trailer, your Volkswagen may require more frequent maintenance due to the extra load.

Do not tow a trailer during the break-in period of your vehicle.

Keep an eye on your coolant temperature gauge. If coolant temperature warning light comes on pull off the road to a safe place to allow engine to cool down.

Maximum trailer weight

A trailer for your vehicle is limited to a typical class I trailer. The maximum gross trailer weight and the tongue load must not exceed the specifications listed in the Technical Information/Data section of this manual.

Do not exceed the gross vehicle weight which is the weight of the driver, passenger, luggage, trailer hitch and tongue weight of the loaded trailer.

Trailer hitch

Use a weight-carrying hitch conforming to the gross trailer weight. The hitch must be suitable for your vehicle and trailer and securely bolted to the body. Always check with the trailer hitch manufacturer to make sure that you are using the correct hitch. Do not use a bumper hitch.

The hitch must be installed in a way not to interfere with the impact-absorbing bumper system. No modifications should be made to the vehicle exhaust and brake systems. From time to time check that all hitch mounting bolts remain securely fastened.

If not towing a trailer for a long period of time, remove the trailer hitch. This prevents the hitch from causing damage should your vehicle be struck from behind.

When removing the trailer hitch, seal all bolt holes to prevent water and exhaust fumes from entering the vehicle.

Trailer brakes

If your trailer is equipped with a braking system, check to be sure that it conforms to all regulations.

The trailer brake system must not be directly connected to the vehicle's brake system.

Tire pressure

When towing a trailer, inflate the tires of your vehicle to the cold tire pressure listed on the label on the left front door jamb. Inflate trailer tires to trailer and tire manufacturer's specifications.

Safety chains

Always use safety chains between your car and trailer.

Trailer lights

Trailer lights must meet all regulations. Do not connect the trailer light system directly to the light system of your vehicle. Be sure to check with your Volkswagen dealer for correct wiring, switches and relays.

Before you tow a trailer

Correct and even load distribution. All objects inside the trailer should be held securely in place to guard against shifting, be it forward, backward or sideways. Never allow a passenger in a moving trailer.

VEHICLE OPERATION

For best roadability adjust your load to the maximum allowed tongue load. To be sure measure tongue load of loaded trailer on bathroom scales.

Check that both sides of your trailer can be seen from the driver's seat. If necessary install extended rear-view mirrors.

Check proper working of vehicle and trailer lights.

Check cold tire pressure of both vehicle and trailer.

Be sure trailer safety chains are properly connected from trailer to the hitch on the vehicle. Leave enough slack in the chains to permit turning corners.

Trailer towing tips

Your vehicle handles differently when towing a trailer because of the additional weight. Safety, performance and economy will greatly depend on how carefully you load your trailer and operate your "rig."

Before you actually tow your trailer, practice turning, stopping and reversing in an area away from traffic until you learn the feel of your vehicle and trailer unit.

Reversing is difficult and requires practice. Steering while reversing is generally opposite of that when backing your vehicle without a trailer.

Observe speed limits. In some areas speeds for vehicles towing trailers are lower than for regular vehicles.

Maintain a greater distance between your vehicle and the one in front. You will need more room to stop.

When passing remember that you cannot accelerate as fast as you normally would because of the added load. Make sure you have enough room to pass. After passing allow plenty of room for your trailer before changing lanes again.

Avoid jerky starts or sudden acceleration.

Slow down in crosswinds and on rough roads. Be especially careful when passing other vehicles and trucks.

When parking always block the wheels of both vehicle and trailer. Do not park with a trailer on a slope. If it cannot be avoided do so only after the following:

- Apply brakes.
- Have someone place wheel blocks under both vehicle and trailer wheels.
- With wheel blocks in place slowly release brakes until wheel blocks absorb the load.
- Apply parking brake.
- Place transmission in "P" for automatic or in first or reverse gear for manual transmission.

DRIVE

The equipment drive conveyor usually kswag engage trans change

Due the S which cation wear ses l

DRIVING YOUR SYNCRO

The Vanagon/Transporter Syncro is equipped with a new type of four-wheel drive system, very much different from conventional systems that have to be manually engaged when needed. The Volkswagen all wheel drive system is always engaged. Only the amount of power being transmitted to the front and rear wheels changes according to requirements.

Due to this extraordinary drive concept, the Syncro is a very efficient road vehicle which has a wide variety of uses and applications. It has proved its virtues in poor weather and road conditions and possesses limited off-road capabilities.

This chapter is provided to help you to sensibly and safely use the superior driving characteristics of the Vanagon Syncro to their best advantage. It also contains technical information and operating instructions to the extent that these vary from those applicable to the conventional Vanagon or Transporter.

Be sure to carefully read this chapter before starting to drive your Syncro so that you will become thoroughly familiar with its features and be able to operate it correctly and safely. Always heed the warnings and other instructions contained in this chapter and in your Owner's Manual.

Because the Vanagon/Transporter Syncro is not an off-road or all terrain vehicle, this chapter does not contain all of the information required to operate such a vehicle under all types of off-road or weather conditions.

Above all use common sense. Do not let the excellent traction of your Vanagon/Transporter Syncro lead you to underestimate the difficulties and risks involved in driving on wet, slippery and rough road surfaces. Always drive defensively and adapt vehicle operation and driving speed to road, traffic and weather conditions.

The function of the all-wheel drive and how it works

In contrast to conventional four wheel drive systems that require transmissions to be manually engaged when needed, the Vanagon/Transporter Syncro all-wheel drive system is always engaged. Only the amount of power being transmitted to the front and rear wheels changes automatically as the road surface demands.

The automatic distribution of power is accomplished through a fluid shear coupling (viscous coupling) that is part of the front axle. The design of the viscous coupling keeps driving force losses to a minimum while distributing the forward thrust to all four wheels when needed.

When the going gets rough, especially when wet, slippery or snow covered roads cause the rear or front wheels to slip, the viscous coupling automatically transfers driving force to the other wheels to help you keep moving.

The distribution of drive forces allows the Syncro to adapt to changing road surfaces and provide increased traction automatically. The Syncro driver is therefore able to fully concentrate on the road and traffic conditions.

This extraordinary drivetrain concept makes the Vanagon/Transporter Syncro an extremely efficient road vehicle suitable for a wide variety of uses and applications. While it has proved its ability to handle poor weather and road conditions and has limited off-road capabilities, remember your Vanagon/Transporter Syncro is not an off-road or all-terrain vehicle.

1 -
2 -
3 -

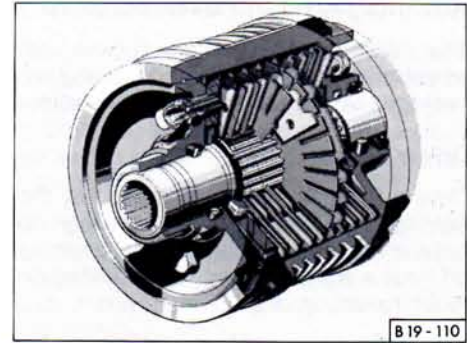
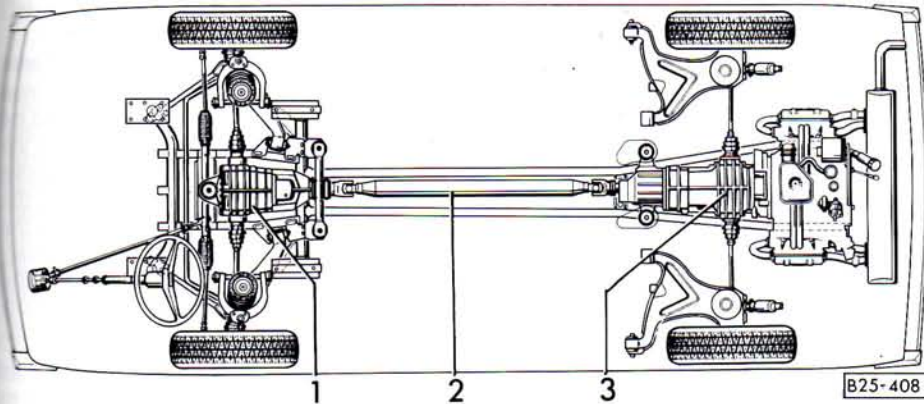

Viscous coupling

- 1 – Front axle final drive and viscous coupling
- 2 – Prop shaft
- 3 – Rear axle final drive

Advantages off the all-wheel drive

The Vanagon/Transporter Syncro all-wheel drive system has the following advantages over a two-wheel drive vehicle:

Driving Power

Driving Power is greatly increased by the continual all-wheel drive especially on snow and slippery surfaces, when starting off from a standstill, and when driving on rough roads.

Within reason, your Vanagon/Transporter Syncro can go places where other vehicles may likely get stuck. It is easier to stop on slippery hills and get going again.

Moving Force

As the driving force applied to the road goes to four wheels instead of two, the amount of slip is considerably reduced. This improves the traction between tire and road surface and thereby, the driveability on slippery road surfaces.

On vehicles with two-wheel drive, the driving wheels can spin on slippery surfaces if too much acceleration is applied. This greatly reduces tire grip and can result in loss of vehicle control.

By distributing the driving forces to four instead of two wheels, the wheels of the Vanagon/Transporter Syncro are less likely to spin under the same conditions.

Snow tires

With the all-wheel drive system the Vanagon/Transporter Syncro is good for winter driving even with standard tires. However, we recommend the use of all season tires or radial snow tires (M+S) with or without studs*, on all wheels, for better driving, cornering and braking, in winter weather.

Details under "Snow tires" on page 118 also apply.

Snow chains

Snow chains can improve both road traction and braking when driving in severe winter weather. Therefore, use snow chains on your all-wheel drive vehicle when required. For additional information, see page 119.

*Check with your local Motor Vehicle Bureau for possible restrictions.

Operation

In contrast to conventional all-wheel drive systems that require transmissions to be manually engaged when needed, the Vanagon/Transporter Syncro all-wheel drive system is always engaged. Only the amount of power being transmitted to the front and rear wheels changes automatically as the road surface demands. The Syncro driver is therefore able to fully concentrate on the road and traffic conditions.

The differential lock* for the rear axle must only be used when the vehicle is stuck or in immediate danger of becoming stuck. For further information on the differential lock, see page 33.

*where applicable

Driving on dry roads

Attention

This is an all-wheel drive multipurpose passenger vehicle which will handle and maneuver differently from an ordinary passenger car in driving conditions which may occur on streets and highways and off-road. As with other vehicles of this type, if you make sharp turns or abrupt maneuvers, the vehicle may roll over or may go out of control and crash. You should read the driving guidelines and instructions in the Owner's Manual. The driver and all passengers should wear safety belts at all times.

Do not engage the differential lock on normal dry roads as it will not provide any advantage. Under these circumstances, an engaged differential lock will impair the vehicle's maneuverability and will cause excessive tire wear.

Driving on wet, slippery roads

Due to the all-wheel drive, the engine power is transmitted evenly to a moderately slippery road surface.

On wet surface

As with any other vehicle, excessive driving speed on very wet roads can cause hydroplaning and loss of vehicle control. Therefore, slow down. The differential lock* must not be engaged.

Important instructions on the differential locks are to be found on page 33/34.

On slippery surfaces

On slippery surfaces the rear axle differential lock* may only be engaged when starting from a standstill or at very low speeds. When the road surface has improved the lock should be disengaged again.

On snow covered surfaces

On a snow covered road, maintain traction by making gradual changes in speed or direction. Avoid sudden maneuvers. Be alert to problems other drivers around you may be having which could create a hazardous situation for you.

In heavy snow, maintaining reasonable momentum is important for safe vehicle operation. Try to keep moving by using the L-gear and a steady accelerator pedal at low speed.

WARNING

■ **Always maintain a safe driving speed, especially when road and weather conditions are poor.**

■ **Excessive driving speed on very wet roads can cause hydroplaning and loss of vehicle control.**

■ **Always avoid forceful and abrupt braking action. You could block all four wheels simultaneously and lose control of the vehicle.**

■ **The braking capability of your Vanagon/Transporter Syncro is greatly dependent on the traction of your tires.**

*where applicable

WARNING continued

■ The permanently engaged all-wheel-drive will provide good performance on relatively wet or slippery roads. Be sure to use these features and advantages wisely. Do not let the excellent traction which your VW SYNCRO offers lead you to underestimate the difficulties and risks involved in negotiating wet or slippery roads. Always drive defensively and adapt vehicle operation and driving speed to road and traffic conditions.

Driving Off-Road

WARNING

The Vanagon/Transporter Syncro is not an off-road or all terrain vehicle. Use of this or any other vehicle under off-road conditions requires special skills and knowledge. The off-road operation of this or any other vehicle can lead to personal injury.

■ Driver and all passengers must wear safety belts at all times.

■ Keep your thumbs and fingers on the outside of the steering wheel. Potholes or rocks can jerk the wheel from your grip; it really hurts if a spoke catches you on the way around.

Off-Road Driving

Driving off-road places extra demands on your vehicle and on you, the driver. If under exceptional circumstances you judge it safe and appropriate to leave the paved highway, first make sure that your vehicle is in top mechanical condition. Make certain that all vehicle systems are functioning normally, in particular, for example, that the engine, especially the cooling system, is operating properly and that transmission, brakes and steering are function-

ing normally. Tires must have adequate tread, be free of damage and be adequately inflated.

Before driving over difficult terrain, such as mud, sand, water, snow or steep slopes, we recommend engaging the differential lock* at low speed. Important information regarding the differential lock is on page 33/34.

Whenever you operate your car you should be well and fit, but your physical and mental condition are especially important when driving off the road.

As a general rule you should go only where others have gone before.

Always obey applicable Federal, State and local regulations and above all respect and protect the environment. Do not scar the land, avoid unnecessary wheel spinning and other driving behavior which will create ruts and destroy vegetation. Be careful when parking and when standing with a hot engine. The catalytic converter with which your vehicle is equipped develops very high temperatures which can set dry grass and brush on fire. Respect the wildlife, leave animals to themselves and do not destroy their areas of refuge. Above all, be considerate and operate your vehicle sensibly and safely. Nature is a natural resource which belongs to all of us.

*where applicable

Volkswagen Professionals— Trained to Know Your Car

Volkswagen owners expect quality customer oriented service. Volkswagen dealers understand this. They provide factory trained and certified technicians, state of the art equipment and genuine Volkswagen parts for your car.

Competent know-how and commitment
to you and your car,
that's Volkswagen Service.

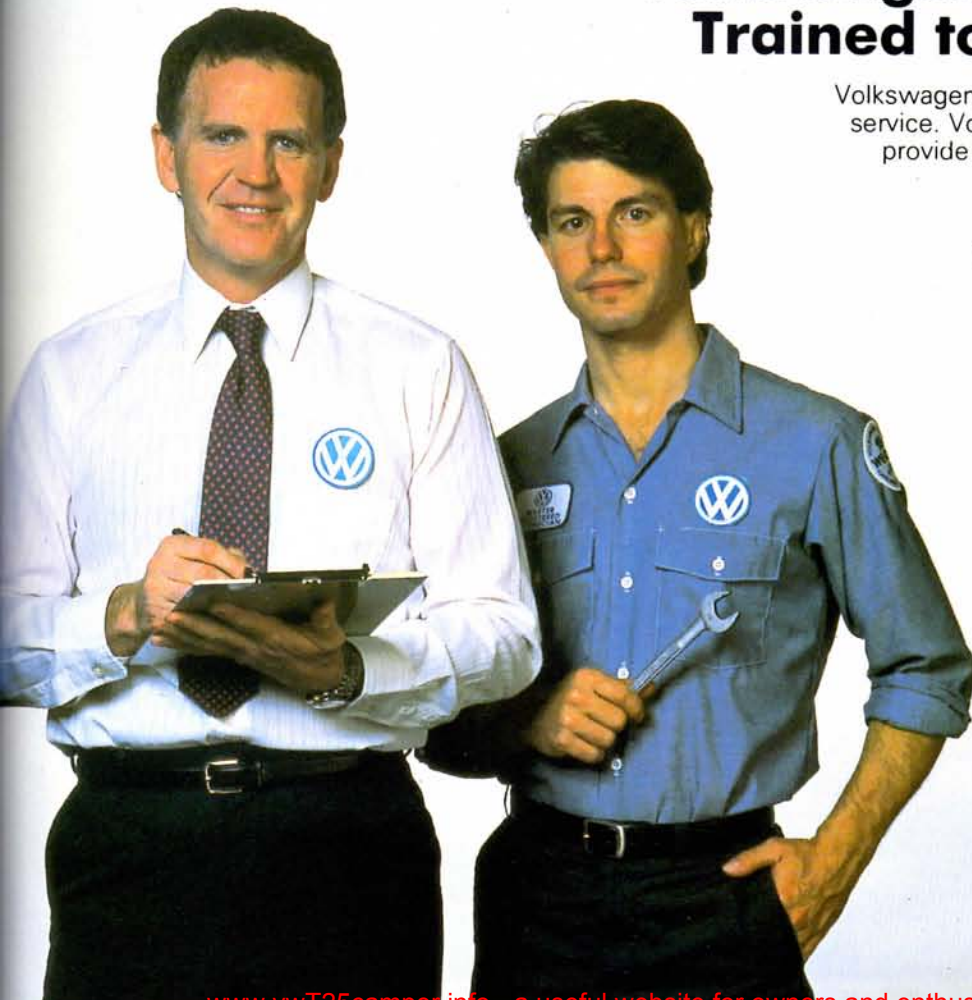

There are only Genuine VW Parts in your new VW. That's one reason why it runs like a new VW.



No one knows your new VW in quite the same way as the people who built it. And when it comes to replacement parts, we build them to the same standards and specifications as the original equipment. We've made sure that these genuine replacement parts are built with the same enduring quality that you would look for in a new VW.

To be sure you're getting the best in genuine replacement parts for your VW, ask your dealer about the Autobahn line of parts. It's a convenient way of choosing from among the most popular maintenance and replacement parts with the kind of quality that you want to put in your automobile.

Shown on the opposite page are just a few of the genuine replacement parts available at our parts department. We'll be glad to help you select the right ones for your car.

And they are backed by our Limited Parts Warranty. Even after your New Car Warranty has run out and you have a repair performed, our Limited Parts Warranty ensures that we will repair or replace every defective Genuine VW Part, used in the repair, for 6 months or 6,000 miles or 10,000 kilometers, whichever comes first.*

Autobahn® Accessories ...specially designed for your Volkswagen.

You'll find a wide selection of "Autobahn" Accessories to help you make your Volkswagen fit your lifestyle even better.

For a sporty flair, there are spoilers, wind-deflectors, fog lights and driving lights.

Select from "Sound Choice" audio components. They are designed to add to your listening pleasure: Electronic radio/cassette combinations with state-of-the-art features and micro switch controls, full-frequency-range high compliance speakers, antennas with fully retractable telescopic masts — manual or automatic — some even with electronic signal amplification.

And there are roof- and rear-deck carriers with special attachments for extra luggage or sporting equipment — ski-, bike-, surfboard carriers, etc. — to expand the usefulness and convenience of your Volkswagen even further.

Autobahn care and protective maintenance products — splashguards, floor mats, chemicals — will help protect your investment in your Volkswagen's good running condition and appearance — inside and out — for many years to come.

Your Dealership Parts Department Professionals will assist you in selecting from our complete line of Autobahn Accessories . . . all designed for your Volkswagen.

Autobahn®

Items available at time of purchase may differ from those shown here.



Driving off-road on Steep Inclines and Sidehills

Before reviewing how to drive up steep hills and along sidehills, make note of an important point. If you don't make it to the top, or your vehicle is about to slide or roll sideways, turn off the engine, put it into first gear, put on the parking brake and get out on the uphill side and walk down. An ounce of prevention is worth a pound of cure.

Steep Inclines

When preparing to climb a steep incline, first find out whether you can make it. If necessary, walk the course. Be sure there is enough clearance on all sides of the vehicle to avoid damage. If you have the slightest doubt don't try it! It is always a good idea to make a trial run to get the feel of the surface and how much effort is needed. Go straight uphill. When the tires begin to spin, apply a little extra gas and let them dig in slightly. Step on the brakes while you shift into reverse and drive straight back down. That's right – in reverse gear, clutch out and driving. Absolutely not in neutral and trying to let yourself down on the brakes. To avoid sideroll remember never turn your vehicle sideways on a hill or steep incline.

On your attempt, give yourself a running start. Accelerate to the hill and then, just as you approach the top, ease off the gas to slow down.

When driving down, keep the vehicle heading straight downhill in low gear and under control. If it begins to slide, don't lock up the brakes. You can't steer a skidding wheel. Touch the gas instead to straighten your car out.



Sidehills

Do not attempt to go across the side of a hill as this is extremely hazardous. If it is absolutely necessary to drive on a hill which is not very steep it should always be done with extreme caution. Whenever possible, avoid doing it! And too, when you're getting out of your vehicle on a sidehill, be sure to always exit on the uphill side.



Surfaces on sidehills are deceptive. What may look like solid ground may actually make your vehicle slide since most of the weight is going to be on the downhill wheels. When your vehicle starts to slide, instantly turn downhill. Take care not to lock the wheels which may cause the vehicle to slide out of control and cause personal injury.

Sand

When driving on sand, be sure to stay on top of it. You can do this by driving with enough speed to maintain momentum.

When crossing short patches of sand, study the situation first and then proceed with cautious and steady speed and keep up the momentum. Avoid long stretches of dry, loose sand. If it is absolutely necessary to drive on dry, loose sand, it may be necessary to partially deflate the tires to increase traction. To avoid getting stuck, maintain a steady but slow speed.

WARNING

Tires must be reinflated when back on hard ground. Just a short distance of driving on hard ground or on pavement with underinflated tires can cause substantial damages to your tires, loss of vehicle control and personal injury.

Water

■ Exercise extreme caution when driving through water. Driving into unfamiliar water can be dangerous. Always check the depth before attempting to make a crossing.

(Wading depth – see page 149).

When it is necessary to drive through deep water, shift into low gear and maintain a steady and slow speed. Engage differential lock* (see page 33).

Be very careful about stopping broadside in a stream of running water as the tremendous force of the water against the flat side of the vehicle could cause it be swept downstream with the current.

With even only a few inches of water running, do not stop if you are on an unpaved surface. Moving water may wash the footing out from under your tires and make it impossible for you to get moving again.

When reaching dry ground, your wet brakes may have very little braking power. Help dry your brakes out by riding your brakes for a short distance to avoid losing control and personal injury.

*where applicable

After driving over difficult terrain, especially through water or mud, the following is important:

- Disengage the differential lock*.
- After long drives through deep mud, the brakes must be checked and cleaned if they are dirty. This will prevent damage to the brakes and premature wear.
- After driving through deep water, take out oil dipstick and check to see whether there are drops of water on the dipstick or if the oil level has risen. In that case, the oil must be changed immediately.
- If during an off-road drive the vehicle has become stuck (dug its way into the ground) or the underside was stuck by rocks or similar, check undercarriage, brake lines and oil pan for damage.
- The engine compartment and vehicle underbody must be cleaned if they are very dirty so that the function of all movable and electrical/electronic parts is maintained.
- Clean heavy soil from wheels and tires, check tires for damage or foreign objects in treads.
- Clean turn signals, lights and license plate.
- Dry brake system by driving a short distance with brake pedal slightly depressed. This will help regaining normal braking action and help prevent the possibility of the vehicle pulling to one side while braking.

Performance testing

If the Vanagon/Transporter Syncro requires testing on a dynamometer (engine output analysis and brake test) the transaxle drive shaft must be disconnected.

The differential lock must not be engaged.

FUEL TANK

The fuel filler neck is located above the right front wheel. Syncro model: above the right rear wheel.

The key A (see page 7) is used for the lockable tank cap. The syncro model has a separate key for the lockable tank cap.

The capacity of the tank is 16.0 gal/60 liters (Reserve is 2.5 gal/10 liters of total capacity).

Syncro model: 18.5 gal/70 liters (Reserve 2.5 gal/10 liters of total capacity).

Trouble-free refueling depends on the correct use of the filler nozzle.

Always insert the nozzle fully into the fuel filler neck, to completely open the spring-loaded flap located just below the filler neck opening. Make sure the filler nozzle is not tilted.

Do not fill the fuel tank too quickly, otherwise the fuel may foam up and cause the nozzle to switch off too soon.

As soon as the nozzle switches off automatically for the first time, the tank is full. Do not try to add more fuel, because the expansion space in the fuel tank will be filled – the fuel can then overflow when it becomes warm.

WARNING

Never carry additional fuel containers in your vehicle. Such containers, full or empty, may leak, cause an explosion, or result in fire in case of a collision.

VEHICLE CARE

FUEL SUPPLY

Your vehicle is equipped with a catalytic converter and requires unleaded fuel.

For maximum engine performance, unleaded fuel with an octane rating of 91 RON, which corresponds to an anti-knock index (AKI) of 87, is recommended.

Do not use leaded gasolines.

Deposits from leaded gasolines deactivate the catalytic converter and thus defeat its purpose to control exhaust emissions.

Unleaded fuels may not be available outside the continental USA and Canada. Therefore, we recommend you do not take your vehicle to areas or countries where unleaded fuel may not be available.

Octane rating

Octane rating indicates a gasoline's ability to resist detonation. Therefore, buying the correct octane gas is important to prevent engine "knock", which reduces performance and may cause engine damage.

Under high load operating conditions, unleaded premium gasoline may be used.

The 91 RON octane rating which you will find above the filler neck is based on the research method. The AKI octane rating usually displayed on USA gasoline pumps is calculated as follows: Research octane number plus motor octane number, divided by 2.

Regular fuels have an octane rating ranging from 91 to 95 **RON** (Research Octane Number) or 87 to 91 AKI.

Do not use any fuel with octane ratings lower than 91 RON or 87 AKI.

Gasolines containing alcohol

Gasoline containing alcohol is available at gas stations in some areas. The gas pump may not be labeled to identify that alcohol is present in the gasoline. If it is labeled, it may not identify what amount and type(s) of alcohol are used. We recommend you use quality gasoline that is **NOT** blended with alcohol. The use of fuel containing

alcohol can cause loss of fuel economy and driveability and performance problems. If these problems are experienced, we recommend you switch to another brand of gasoline.

Seasonally adjusted gasoline

Many gasolines are blended to perform especially well for winter or summer driving. During seasonal change-over, we suggest that you fill up at busy gas stations where the seasonal adjustment is more likely to be made in time.

Gasoline additives

A major concern among many auto manufacturers is carbon deposit build-up caused by the type of gasoline you use.

Although gasolines differ from one manufacturer to another, there is a common thread. All gasolines contain properties that can cause deposits to collect on essential engine components, specifically fuel injectors and intake valves. Although most gasoline brands include additives to keep engine and fuel systems clean, they are not equally effective.

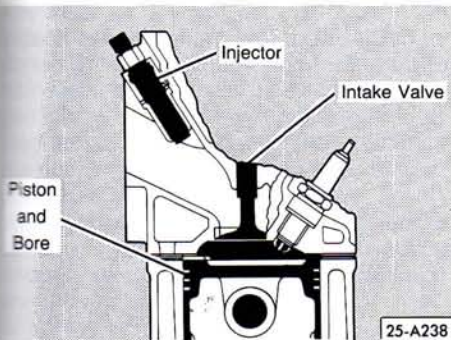

After an extended period of using inadequate fuels, built-up carbon deposits can rob your engine of peak performance. And carbon deposits like those in the illustration can lead to other engine performance problems such as:

- unstable idling
- surging
- misfiring
- power loss
- engine run-on
- engine pinging or knocking

If these problems continue over a long period of time, engine damage can be a result.

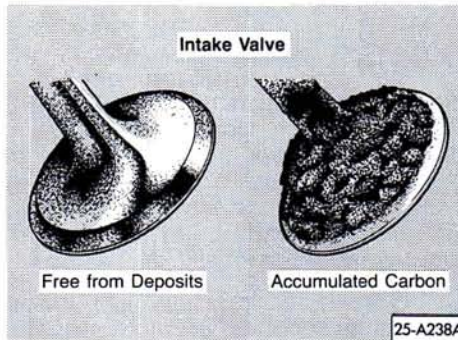

Damage or malfunction due to poor fuel quality is not covered by the Volkswagen New Vehicle Limited Warranty.

Recent fuel developments

Over the past few years, more manufacturers have been advertising detergent additives in their gasoline. These additives are primarily intended to keep fuel injectors clean.

However, they are not all equally effective in reducing carbon deposit build-up on intake valves. We are aware that, as of the time of printing, some manufacturers

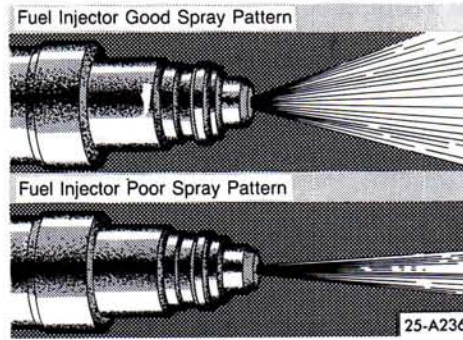

advertise and sell gasoline that contains the proper deposit control additives that will keep intake valves and injectors clean.

To assure the long term performance of your car's engine, you should use gasoline brands that include these deposit control additives.

If gasolines with additives are not available, contact your Volkswagen dealer about proper fuel additives.

If wrong fuel was put into your tank

Premium gasoline instead of regular

Your engine runs equally well on premium gasoline, however neither fuel consumption nor engine output are likely to be affected.

Regular gasoline with RON/AKI rating (lower than 91 RON or 87 AKI)

Your engine will run but avoid full power as engine can be damaged. Fill up with correct fuel as soon as possible.

Diesel fuel instead of gasoline

Your gasoline engine must not be started with Diesel fuel in the tank. In such case the fuel tank must be drained while observing all environmental and fire hazard precautions.

Leaded instead of unleaded gasoline

Do not drive your car. Have your fuel tank drained immediately as otherwise the emission control system will be damaged.

The fuel system must be drained while observing all environmental regulations, it is best to have this performed by your Volkswagen dealer.

CLEANING PRODUCTS

Any automobile is subjected to abuse from industrial fumes, corrosive road salt, abandoned lollipops, muddy dog feet, etc.; to name just a few. A well cared for Volkswagen can look like new many years later. Regular and correct care will contribute to maintaining the beauty and the value of your Volkswagen.

Your Volkswagen dealer has a number of car-care products and can advise you which ones to use for cleaning the exterior and interior of your vehicle.

Whether you use Volkswagen recommended products or other, commercially available cleaning agents, make sure first of their correct application.

WARNING

- **Cleaning agents may be poisonous. Keep them out of the reach of children.**
- **Observe all caution labels.**
- **Always read directions on the container before using any product.**
- **Most chemical cleaners are concentrates which require dilution.**
- **Only use spot removing fluids in well ventilated areas.**
- **Do not use gasoline, kerosene, naphtha, nail polish remover or other volatile cleaning fluids. They may be toxic, flammable or hazardous in other ways.**

EXTERIOR

Washing and waxing

The paint on your Volkswagen is very durable but must be protected from losing its luster due to outside influences. Therefore, wash and wax your Volkswagen often. The longer the dirt is left on the paint, the greater the risk of damaging the glossy finish, either by scratching if the dirt is rubbed into the paint, or simply by the chemical effect dirt particles have on the paint surface.

Do not wash or wax in direct sunlight, or when the sheet metal is hot. Do not use hot water. Lukewarm to cool water is kinder to the paint.

WARNING

- **Do not wash, wax or dry the vehicle with the engine running.**
- **Do not clean the underside of chassis, fenders, wheel covers, etc., without protecting your hands and arms. You may cut yourself on sharp-edged metal parts.**
- **Moisture, ice and road salt on brakes may affect braking efficiency. Test the brakes carefully after each vehicle wash.**

Do not aim the water jet directly at door, hatch or rear lid locks. Tape the key holes to prevent water from seeping into the lock cylinders. Water in lock cylinders should be removed with compressed air. To prevent locks from freezing in the winter, squirt glycerine or lock de-icer into the lock cylinders. **Do not use any solution that can damage the body paint.**

Use plenty of water, a car-wash and wax solution and a soft sponge or hose brush. Begin by spraying water over the dry surface to remove all loose dirt before applying the car-wash and wax solution. Use plenty of water to rinse the vehicle off. Wipe everything dry with a chamois to avoid water spots.

When having your vehicle washed at an automatic car wash, be sure to observe all the precautions suggested by the establishment.

The underside of the vehicle picks up dirt and road salt. To guard against corrosion, it is important to remove mud, debris and road salt from the underside with a powerful jet of water. Be sure to include the wheel housings, bumpers, muffler, tailpipe and brackets. This should be done twice a year and is best accomplished after the vehicle has been driven through a heavy rain. Let engine and exhaust cool down before washing.

Waxing is not really needed when you have used a car-wash and wax solution. If you do not use a car-wash liquid with wax, apply wax to preserve the natural shine of the body paint. To obtain a long lasting finish, apply hard wax. Wax again when water remains on the surface in large patches instead of forming beads and rolling off.

This will make dirt easier to remove and will prevent the paint from being damaged from industrial dust, tree sap or bird droppings.

Use a polish when it becomes evident that waxing no longer accomplishes the job. If the polish you are using does not contain wax, apply hard wax after polishing.

Tar or oil

Do not allow tar or oil to remain on the paint. Remove as soon as possible with a cloth soaked with a special paint cleaner. If you do not have a tar or oil remover, you may substitute with turpentine. After applying a cleaning fluid, always wash with a lukewarm soap water solution and apply a new wax coat.

Insects

Remove as soon as possible with a lukewarm soap water solution or insect remover.

Tree sap

Do not allow tree sap or bird droppings to harden on the paint. Remove with a lukewarm soap water solution.

Touch-up paint

Your Volkswagen dealer has touch-up paint for minor scratches and stone chips. Scratches should be touched up soon after they occur to prevent corrosion. If corrosion formation becomes visible, however, a simple touch-up job will not suffice.

The affected surface must be smoothed with sand paper and covered with an anti-rust primer, before restoring the painted finish.

The number for the original vehicle paint can be found on the vehicle identification label.

Windows

Clean all windows regularly to remove road film and car-wash wax buildup. Use a lukewarm soap water solution or an alcohol base commercial window cleaning agent. If a chamois is used for polishing the glass, it should exclusively be used for that purpose.

Also, be sure to clean all windows regularly on the inside.

Use a plastic scraper to remove snow and ice from windows and mirrors. To prevent dirt from scratching the window, always scrape in a forward direction – never back and forth.

Wiper blades

Always loosen frozen wiper blades from glass otherwise they may tear.

Clean wiper blades regularly with an alcohol base solution. If necessary, use a sponge or a brush to remove accumulated road film. To assure good visibility, replace wiper blades at least once a year, or more often when wiping becomes streaky. For instructions on replacing wiper blades, see page 113.

Weatherstrips

Keep silicone sprays off the windshield to avoid wiper smear in rain.

To seal properly, weatherstrips around hood, hatch, windows, doors, etc., must be pliable. Spray with silicone or coat with talcum powder or glycerine to retain flexibility of the rubber and to protect against freezing in the winter.

Sliding roof guide rails

To assure that the sliding roof* function properly, clean the guide rails and lubricate with silicone spray at least once a year. See your Volkswagen dealer for correct procedures and lubricant.

Dull finishes and plastics

Plastic parts, such as light bulb lenses, decorative stripes, panels, bumpers, etc., will come clean with regular washing. Should additional cleaning or spot removal be necessary, use a soft brush or cloth soaked with a mild detergent solution. Then rinse thoroughly and immediately with clear water.

Do not use anything which could mar the plastic or dull finished surface, such as wax, polish, abrasive detergents or chemical cleaning solvents.

Sliding door

The sliding door mounting points, the guide tracks and the roller guides should be lubricated regularly and as often as necessary.

Bright metal trim

Bright or black anodized trim will come clean with regular washing. To protect metal trim, use car wax. Remove spots or dirt from chrome and stainless steel with a chrome cleaner. Apply a chrome polish for continued luster and protection.

Steel wheels

Always include the hub caps and wheel rims when washing your vehicle to remove road dirt, salt sprays and brake dust. If necessary, use a commercial wheel cleaner to remove accumulated brake dust. Paint scratches should be touched up to prevent corrosion.

Light alloy wheels

To preserve the decorative appearance of the light aluminium cast, some special care is necessary. In addition to road dirt and salt sprays, brake metal dust is also corrosive. If left on too long, brake metal dust can cause pitting. Wash the wheels with a sponge or hose brush every other week. Road salt should be removed weekly with an acid free cleaning solution. Every three months (after regular cleaning) the wheels should be coated with petroleum jelly or car wax. Rub it in firmly with a soft cloth. Never use abrasive or metal polishing cleaning agents.

Remember that moisture, ice and road salt on brakes may affect braking efficiency. Test the brakes carefully after each washing. Heed warning on page 29.

INTERIOR

Glass

Use the same cleaning agents as for exterior and polish dry.

Fabric

Use a vacuum cleaner or a soft bristle brush to remove dust and loose dirt from carpeting, upholstery, headliner and other trim. Dirt stains can usually be removed with a lukewarm soap water or all purpose cleaner solution, or a dry foam cleaner. For greasy, oily and other stubborn stains, use a spot remover. Do not pour the liquid on the fabric. Dampen a clean cloth and rub carefully, starting at the edge and working inward.

Plastic, vinyl and leather/leatherette

Use a clean, damp cloth or sponge to keep this trim free from dust. For other soilage, use a lukewarm solvent free all purpose cleaning solution or a mild saddle soap for vinyl and leather trim. Remove water spots and soap traces with a clean, damp cloth or sponge. Use a clean, soft cloth to rub dry.

Grease, tar or oil stains can be removed with a clean cloth or sponge soaked with all purpose cleaner or with a solvent type vinyl or leather cleaning agent.

Occasionally apply a colorless vinyl or leather preservative to retain the material's luster and pliability.

Safety belts

Keep belts clean. Dirty belts may not retract properly. Do not remove belts from the vehicle. Do not use chemical cleaning agents, bleach or dyes. They contain corrosive properties which will weaken the webbing. Do not allow inertia reel safety belts to retract before they are completely dry.

For cleaning, use a mild soap water solution. Let belts dry out thoroughly and away from direct sun light.

Use the opportunity to inspect the belts for damage. If you discover damage, see your dealer.

VEHICLE CARE

CORROSION PROTECTION

The transmission, front and rear axle assembly surfaces have been treated at the factory with a wax based coating for protection against corrosion. However, we recommend to have the and the underside inspected twice a year for any damage to the protective coating preferably before and after the winter season. Have necessary repairs done as soon as possible. See your dealer for correct procedures and materials.

WARNING

Do not apply additional undercoating or rustproofing on or near the exhaust manifold, exhaust pipes, catalytic converter or heat shields. During driving, the substance used for undercoating could overheat and cause a fire.

Engine Compartment

When washing the engine compartment, only use commercially available grease cutting solvents made especially for this purpose. Carefully follow directions printed on the container by the manufacturer.

WARNING

Never use gasoline, Diesel fuel or solvents which could damage rubber parts or painted surfaces and could cause a fire.

Chassis

The lower body shell of your Volkswagen is thoroughly protected against corrosion. However, it is recommended to have the underside inspected twice a year. Any detected damage to the undercoating, due to road hazards, should be repaired promptly. Oil based protective sprays must not be applied. Only tar or wax based anticorrosion protectors are compatible with the factory applied undercoating. Before application, road dirt, salt spray deposits and oily substances must be removed.

Whenever the lower body shell, axle, transmission or engines assemblies have been repaired, the lost anti-corrosion coating of the affected surfaces should be reapplied.

Your Volkswagen dealer has the appropriate materials, the necessary equipment and is familiar with the application procedure. Therefore, any additional corrosion protection work should be performed by a Volkswagen dealer.

Body cavity sealing

All body cavities which could be affected by corrosion have been given a thorough protection at the factory.

This sealing does not require any inspection or additional treatments. If any wax should seep out of the cavity when the ambient temperature is high, it can be removed with a plastic scraper and a suitable solvent. Be sure to observe all safety and environmental regulations.

MAINT

our vel
keep ma
num. H
ear main
ure you
ability.

Mainten
2 mon
ilome

n addit
change
Service
ilome

The fir
month
after 7

MAINTENANCE

Your vehicle has been designed to help keep maintenance requirements to a minimum. However, a certain amount of regular maintenance is still necessary to assure your vehicle's safety, economy and reliability.

Maintenance Service is required every 12 months or every 15,000 miles (24,000 kilometers), whichever occurs first.

In addition, it is necessary to perform an oil change 6 months after each Maintenance Service, or after each 7,500 miles (12,000 kilometers) whichever occurs first.

The first oil change must be performed 6 months after the delivery of the vehicle or after 7,500 miles (12,000 kilometers).

Under difficult operating conditions, for example at extreme low outside temperatures or in very dusty regions, etc., some service work should be performed between the intervals specified.

This applies particularly to:

- oil changes, and
- cleaning or replacing the air filter.

The maintenance work should be performed by Volkswagen dealers because they have the expertise, the workshop facilities and the special tools required. It is important that this work is performed according to the manufacturer's instructions.

Proof of servicing in accordance with the maintenance schedule may be a condition for upholding a possible warranty claim made within the warranty period.

Safety and environmental concerns place very strict limits on the nature of repairs and adjustment on engine and transmission parts which an owner can perform. **Tampering with safety-related parts can endanger you as well as other motorists.**

Always observe environmental regulations when disposing of old engine oil, used brake fluid, dirty engine coolant, spent batteries or worn out tires.

Important Consideration for you and your car:

A thorough and detailed preventive maintenance schedule has been developed for your vehicle, which if followed should help assure you of years of reliable and dependable use. We strongly urge you to give your dealer the opportunity to perform all scheduled maintenance and necessary repairs. He has the facilities, original parts and trained specialists to keep your car running properly.

The increasing use of electronics, sophisticated fuel injection and emission control systems together with the generally increasing technical complexity of today's automobiles has steadily reduced the scope of maintenance and repairs which can be carried out by vehicle owners. Maintenance, adjustments and repairs usually require special tools, testing devices and other equipment by specially trained workshop personnel in order to assure proper performance, reliability and safety of the vehicle and its many systems. Improper maintenance, adjustments and repairs can impair the operation and reliability of your car and even void your vehicle warranty. Above all operational safety can be adversely affected creating unnecessary risks for vehicle occupants and others.

This section describes a limited number of procedures which can be performed upon your vehicle with ordinary tools, should the need arise and trained personnel be unavailable. Before performing any of these procedures, always thoroughly read all of the applicable text and carefully follow the instructions given. Always rigorously observe the WARNINGS provided.

WARNING

Serious personal injury may occur as a result of improperly performed maintenance, adjustments or repairs.

■ **The engine compartment of any motor vehicle is a potentially hazardous area.**

■ **Do not attempt any of the maintenance, checks or repairs described on the following pages if you are not fully familiar with these or other procedures with respect to the vehicle, or are uncertain as to how to proceed. Have the necessary work done by your Volkswagen dealer or any other properly equipped and qualified workshop.**

■ **Always support your vehicle with safety stands if it is necessary to work underneath the vehicle. The jack supplied with the vehicle is not adequate for this purpose.**

■ **If you must work underneath the vehicle without safety stands but with the wheels on the ground, always make sure the vehicle is on level ground, that the wheels are always securely blocked and that the engine cannot be started. Always remove the ignition key.**

■ **Always be extremely careful when working on the vehicle. Always follow commonly accepted safety practices and general common sense. Never risk personal injury.**

Note

Incomplete or improper servicing may cause problems in the operation of the vehicle and may reduce or eliminate your warranty coverage. If in doubt about any servicing, have it done by your Volkswagen dealer or any other properly equipped and qualified workshop.

ENGINE COMPARTMENT LID

You have access to the engine compartment lid from inside the luggage compartment.

To open the lid, roll the floor covering out of the way and turn both lock handles to the left.

To close the lid, reverse the above procedure.

ENGINE COMPARTMENT

Always exercise extreme caution when working on the engine.

WARNING

■ Before you check anything in the engine compartment, stop the engine, fully set the parking brake and remove the ignition key.

■ Do not work on your car if you are tired or ill, under emotional stress or under influence of drugs, medication or alcohol.

■ Always let the engine cool down. Hot components will burn skin on contact.

■ Do not spill engine oil, ATF, brake fluid, antifreeze and washer solvent on hot engine components, especially not on the exhaust system. These fluids are flammable.

■ Always disconnect the battery ground strap if you must work on the fuel system or the electrical system. Never smoke or work near heaters or other fire hazards if you must work around fuel. Always keep an approved fire extinguisher immediately available.

Be especially careful if engine is running:

■ If work must be done with the engine running, always fully set the parking brake, and make sure the shift lever is in Neutral (Manual transmission) or Park (Automatic transmission).

■ Always be alert and extremely cautious around the engine at all times particularly when the engine is running.

■ Always exercise extreme caution to prevent neckties, jewelry, long hair or loose clothing from getting caught in the fan blades, the V-belts, or any other moving engine parts.

■ To avoid electrical shock and personal injury never touch ignition cables or components of the high voltage electronic ignition system while the engine is running or even when starter is cranked.

VEHICLE CARE

LUBRICANTS

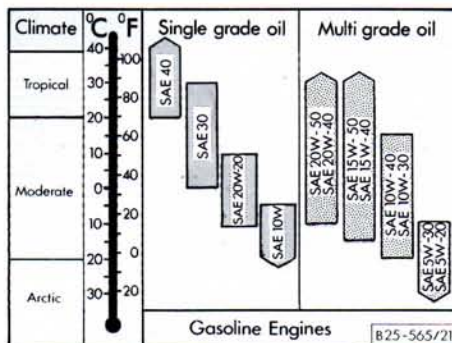

Engine

Your engine was factory filled with an all-season high quality engine oil. If you need to add oil between oil changes use any high quality petroleum or synthetic based oil with correct specifications.

The following term must appear on the oil container singly or in combination with other designations: "API Service SF or SG".

Engine oils are graded according to their viscosity. The proper grade to be used in your engine depends on existing climatic or seasonal conditions.

Refer to the temperature chart when selecting engine oil. As temperature ranges of the different oil grades overlap, brief variations in outside temperatures are no cause for alarm. It is also permissible to mix oil of different viscosities if you find it necessary to add oil.

When using SAE 10 W or SAE 5 W-20 or SAE 5 W-30 engine oil, avoid high speed long distance driving if outside temperature rises above the indicated limits.

Engine Oil Identification Symbol

Select an oil for your vehicle which conforms to the standards of the American Petroleum Institute (API). A symbol has been added to the top of some oil containers to help in selecting the correct oil.

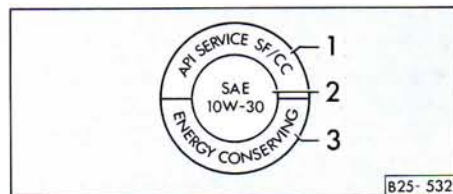

- (1) The top portion indicates the oil quality by API designations.
- (2) The center portion shows the SAE oil viscosity grade.
- (3) The lower portion indicates that the oil has fuel saving capabilities.

Transmission

Manual transmission:

Hypoid oil SAE 80 (Mil-L-2105 or API/GL 4).

Automatic transmission:

ATF Dexron® or Dexron II® for torque converter and hypoid oil SAE 90 (Mil-L-2105 B or API/GL 5) for final drive.

Front axle differential (Synchro only)

Hypoid oil SAE 80 (Mil-L 2105 B or API/GL 4) or synthetic transmission oil G 50, SAE 75 W-90.

The lubricant used does not have to be changed.

Should the need arise to add oil, it should only be done with the necessary workshop equipment.

Power steering

ATF Dexron®

Lubricant additives

Volkswagen does not recommend the use of oil additives. It may adversely affect your warranty.

ENGINE OIL

Engine oil consumption

It is normal for your engine to consume oil. The rate of oil consumption depends on the quality and viscosity of oil, the speed at which the engine is operated, the climate, road conditions as well as the amount of dilution and oxidation of the lubricant.

Because of these variables, no standard rate of oil consumption can be established, but drivers should expect an increased oil consumption at high speeds and when the engine is new.

The engine in your vehicle depends on oil to lubricate and cool all of its moving parts. Therefore the engine oil should be checked regularly and kept at the required level.

Make it a habit to have the engine oil level checked with every fuel filling.

Lack of sufficient engine oil may lead to severe engine damage.

The oil pressure warning light is not an oil level indicator.

Always heed WARNINGS on page 97.

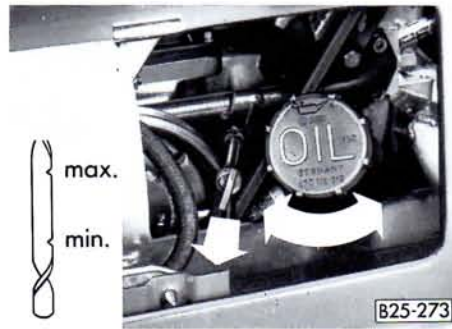

The engine oil dipstick and the oil filler neck are located behind the license plate lid.

Checking the engine oil level

The best time to check the engine oil level is when the oil is warm.

- Turn off the engine.
- To get a true reading, the vehicle should be on level ground. After turning off the engine, wait a few minutes for the oil to return to the crankcase.
- Flip license plate down.
- Pull out dipstick and wipe it clean with a rag.
- Reinsert dipstick; push it in all the way.

■ Pull dipstick out again. The oil level is correct if it is between the "max" and "min" marks on the dipstick.

■ If oil level is below "min" mark, or not showing on dipstick, add oil immediately.

■ Make sure that the dipstick is completely in.

Adding engine oil

■ Unscrew cap from oil filler neck.

■ Pull extension tube out of filler neck as far as it will go.

■ Only add the amount of oil needed. The difference between the "min" and "max" marks on the dipstick is about 1 U.S. quart or 1 liter. Always select a quality oil with the correct specification. See "Lubricants" on page 85.

Do not exceed the MAX marking.

Otherwise, the excess oil may be drawn in through the crankcase breather into the exhaust system. The oil would then burn in the catalytic converter and cause damage.

■ Push in the extension tube, replace filler cap and hand tighten securely.

WARNING

The oil filler cap must be secure to avoid oil spill causing fire hazard.

Changing the engine oil

Have your engine oil changed regularly, but at least twice a year (see Maintenance booklet).

This is very important because the lubricating properties of oil diminish gradually during normal operation of the vehicle.

If you drive mostly short distances, or if you operate the vehicle in dusty areas, or under predominantly stop-and-go traffic conditions, or when temperatures remain below freezing for extended periods, the engine oil should be changed more frequently.

Due to the detergent additives in the oil, the fresh oil will look dark after the engine has been running for a short time. This is normal and there is no reason to change the oil more often than recommended by the manufacturer.

Always heed WARNINGS on page 96 and 97.

WARNING

■ **Drain the oil into a container that is designed for this purpose, one that is large enough to hold at least the oil filling of your engine.**

■ **Wear eye protection.**

■ **To reduce the risk of burns from hot engine oil let the engine cool down to the touch.**

■ **When removing the oil drain plug with your fingers, keep as far away as possible. Always keep your forearm parallel to the ground to help prevent hot oil from running down your arm.**

■ **Engine oil is poisonous. Keep it well out of the reach of children. Continuous contact with used engine oil is harmful to your skin. Always protect your skin by washing thoroughly with soap and water.**

■ **Always dispose of used engine oil properly. Do not dump it on garden soil, wooded areas, into open streams or down sewage drains.**

■ **Recycle used engine oil by taking it to a used engine oil collection facility in your area, or contact a service station.**

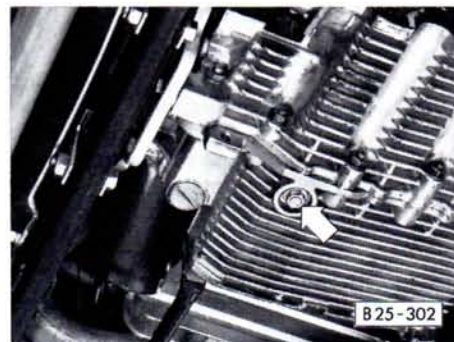

■ **Turn off the engine.**

■ **Remove the oil drain plug (arrow) when the engine is still warm and allow the oil to drain.**

■ **Always use a new gasket when reinstalling the plug. Do not overtighten.**

■ **Fill the engine with oil. Do not overfill.** Always check engine oil level with dipstick as described on previous page.

Engine oil capacity is listed under "Capacities", page 147.

Local zoning ordinances or environmental regulations will tell you how you can dispose of used engine oil. Should the discarding of the old oil present a problem to you, we suggest you have the oil changed at your dealer or a service station.

ENGINE OIL FILTER

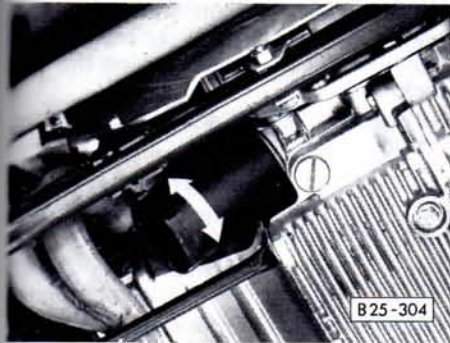

- Screw on filter element and hand-tighten according to manufacturer's instructions on the carton or on the filter element.

- Fill engine with appropriate amount of engine oil.

- Run engine at various speeds for three to five minutes and check for leaks.

- Check dipstick for correct oil level, top up if necessary.

Changing the oil filter

The oil filter should be changed at the intervals listed in your Maintenance booklet.

- Remove old oil filter element and discard.

- **Use only Oil filter part No.: 070115561 as otherwise engine damage can occur.**

- Lightly coat seal of new filter element with oil.

Always heed WARNINGS on page 96 and 97.

VEHICLE CARE

AUTOMATIC TRANSMISSION FLUID / MANUAL TRANSMISSION OIL

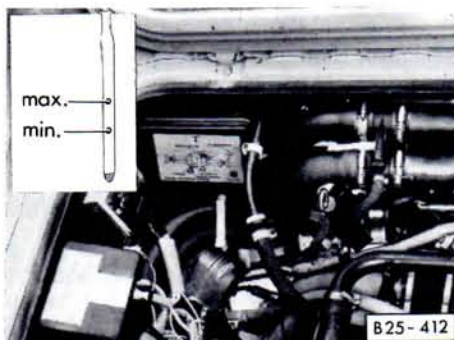

Automatic Transmission Fluid

The torque converter and the transmission are lubricated with Automatic Transmission Fluid (ATF).

The final drive requires hypoid oil SAE 90, which does not have to be changed.

Checking the ATF level

The ATF has to be checked at frequent intervals, for instance, when the engine oil is being checked or at least at the intervals specified in your Maintenance booklet.

Always heed WARNINGS on page 97.

A correct ATF level is very important for transmission operation.

To obtain an accurate reading, the vehicle must be on level ground, and the fluid must have reached operating temperature. Normally, after a cold-start the fluid will reach operating temperature when the vehicle has been driven for about 6 miles or 10 km. If the ATF is too cool or too hot, the fluid level reading will be inaccurate.

WARNING

Before checking the ATF, the selector lever must be securely locked in the Park position and the parking brake applied firmly.

Checking the ATF level is potentially hazardous because the hot engine has to be running during the check. Do not attempt to check the ATF before reading all WARNINGS on page 97.

The ATF filler neck is in the engine compartment on the left hand side. The dipstick is attached to the plug. Pull it out and wipe clean first before inserting it to take a reading.

The Automatic transmission may be damaged by even a tiny speck of dirt. Only use lint free rags to wipe the dipstick.

To get a true reading, the ATF must be at operating temperature.

You have enough ATF if the fluid level is between the two marks on the dipstick. It should never be above or below these marks. If level is too high or too low do not just add or drain ATF. Have your dealer check and correct the cause as soon as possible.

For correct ATF specifications, see "Lubricants" on page 85.

Changing the ATF

The ATF has to be changed at the intervals specified in your Maintenance booklet.

Do not tow the vehicle or run the engine without ATF in the transmission.

Manual Transmission Oil

Both transmission and final drive are combined in one housing. The lubricant used is hypoid oil which does not have to be checked or changed. If you should suspect a leak, contact your VW dealer.

AIR CLEANER

A dirty filter element reduces engine output and increases fuel consumption and can cause premature engine wear.

Normally, it is not required to service the air cleaner more often than recommended in the Maintenance booklet. If the vehicle is driven on very dusty roads, the air cleaner must be serviced more frequently, even daily. We recommend that you have the air cleaner serviced by your Volkswagen dealer or a qualified workshop.

If your air filter must be changed more frequently, we recommend that you have your Volkswagen dealer show you the procedure before you attempt doing it yourself.

The paper filter element must never be cleaned or soaked with gasoline, cleaning solvents or oil.

POWER STEERING*

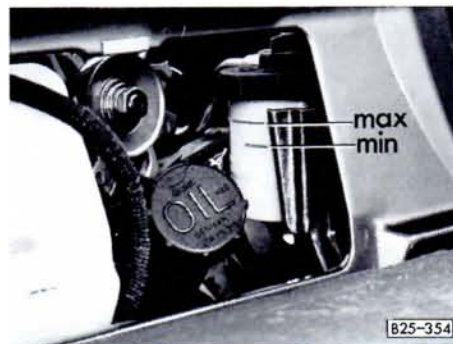

The fluid reservoir is located behind the licence plate lid.

The power steering is filled with ATF Dexron®.

A correct fluid level in the reservoir is important for the proper functioning of power steering.

With the engine running, the fluid level in the power steering system must be checked at regular intervals. The fluid level should always be between the "max" and "min" markings. If the level should go below the "min" marking, have the power steering system inspected by your Volkswagen dealer. It is not sufficient to just add hydraulic fluid.

*where applicable

WARNING

■ Be sure not to confuse brake fluid and hydraulic fluid. If the wrong fluid is used, the systems may fail.

■ If the power steering system should fail, or if the engine is not running (for example while being towed), you will still be able to steer the vehicle, however, more effort will be required.

Note

Since the hydraulic fluid also functions as a lubricant, serious damage to the pump and to other components of the system could result if there is insufficient hydraulic fluid in the system.

Always heed WARNINGS on page 97.

COOLING SYSTEM

The cooling system is sealed and generally requires little attention.

The cooling system has been filled at the factory with a permanent coolant which does not need to be changed. The coolant consists of a mixture of water and the manufacturer's coolant additive G 11 – antifreeze on glycol basis with anticorrosion additives (40% for USA models; 50% for Canadian models). This mixture assures the necessary frost protection and protects the entire cooling system against corrosion and scaling, and raises the boiling point of the coolant.

Do not reduce the concentration of the coolant in the summer by adding plain water. **The coolant additive proportion must be at least 40% but not more than 60%**, to maintain the antifreeze protection and the cooling efficiency.

For year round driving, antifreeze is added at the factory for temperatures down to:

–13° F/–25° C (USA)

–40° F/–40° C (Canada)

Only use quality phosphate-free antifreeze containing ethylene glycol. Such antifreeze is available at your Volkswagen dealer.

WARNING

Antifreeze is poisonous. Always store antifreeze in its original container and well out of the reach of children. If you drain the coolant, it must be caught and safely stored. Drained coolant should normally not be reused. Always dispose of used coolant observing all environmental regulations.

Coolant losses

Coolant losses may indicate a leak in the cooling system. In this case, the cooling system should be inspected immediately by your Volkswagen dealer. It is not sufficient merely to add coolant.

In a sealed system, losses can only occur if the boiling point of the coolant is exceeded as a result of overheating.

Overheating can occur if:

- the flow of air to the radiator is obstructed by leaves, dust, insects or by additional lights installed in front of the radiator grille;
- the boiling point of the coolant has been reduced due to an incorrect mixture of coolant and water;
- the radiator fan is not working – see "Radiator fan", or;
- the vehicle is being driven up a long hill in a low gear with engine speed very high and at very high ambient temperature – see "Radiator fan".

If the cause for the overheating cannot be determined and corrected, contact your Volkswagen dealer immediately, otherwise serious engine damage could result.

Always heed WARNING on page 97.

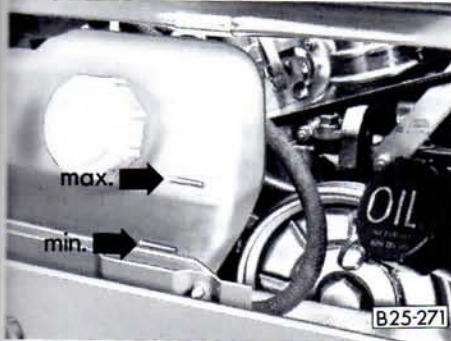

Refill tank

Checking the coolant level

The coolant level should be checked from time to time, and always before going on a longer trip.

WARNING

To reduce the risk of being burned, never open the hood if you see or hear steam or coolant escaping from the engine compartment. Wait until no steam or coolant can be seen or heard before carefully opening the hood.

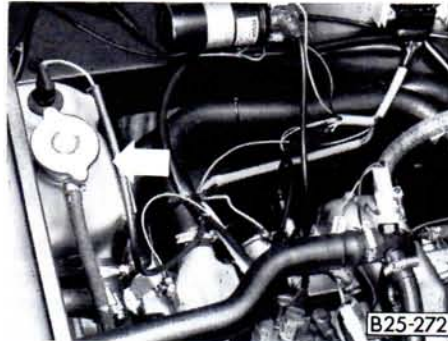

Expansion tank

The refill tank and the expansion tank are in the engine compartment.

The coolant level is normally checked only in the refill tank (behind the license plate lid).

The expansion tank needs checking only if a large amount of coolant is lost or if the warning light in the water temperature gauge lights up.

On the refill and the expansion tank, the cap need not be taken off, since the tanks are transparent.

On the refill tank, the coolant level must be between the min. and max. marks when engine is cold and not running. When engine is warm, coolant level may be slightly above max. mark.

The expansion tank is equipped with an electric coolant level checking device. When the coolant level is too low, the warning light in the coolant temperature gauge (see page 43) will flash until the coolant level has been restored to normal.

Adding coolant

Turn off the engine and allow it to cool down.

WARNING

Reduce the risk of scalding from hot coolant by following these steps.

■ If the cap from the expansion tank must be removed wait until the engine has cooled down. The cooling system is under pressure.

■ Protect face, hands and arms by covering the cap with a large, thick rag to protect against escaping fluid and steam.

■ Carefully and slowly turn cap one turn to allow excess pressure to escape before completely removing cap.

Top up coolant in refill tank. Only when cooling system was drained or a lot of coolant needs to be added, also fill expansion tank.

To maintain the anti-corrosion properties of the coolant, the antifreeze concentration should not be reduced, even during the warm season.

Increasing the antifreeze in the coolant to more than 60% is not only uneconomical, it is also detrimental to engine cooling.

Only use quality phosphate-free antifreeze containing ethylene glycol. Such antifreeze is available at your Volkswagen dealer.

Antifreeze, other than specified by Volkswagen, may cause corrosion of the cooling system, leading to engine overheating and damage.

Only for topping-up coolant, a small amount of antifreeze containing ethylene glycol and phosphates may be used, if recommended antifreeze is not available.

■ After adding coolant, run the engine at idle speed for a few seconds.

■ Wait for the radiator fan to switch on and off again.

■ Check coolant level. Add more coolant if necessary.

Do not overfill the system.

Excess coolant will be forced out through the pressure relief valve in the reservoir when the engine becomes hot.

Screw cap on again tightly.

Radiator fan

The electric radiator fan (located in front of the car behind grille) is controlled by thermostats from the coolant and engine compartment temperature.

After turning off the engine, the radiator fan can continue to run (up to 10 minutes). It may also suddenly start to run again even with the ignition switched off.

Notes

■ If the radiator fan does not come on when the coolant temperature is very high, check the fuse and replace it if necessary – see page 129.

■ The speed of the radiator fan does not depend on the engine speed, therefore cooling effect cannot be increased by downshifting. As long as the engine runs smoothly and driving an uphill road does not considerably reduce speed, there is no need to downshift.

Always heed WARNINGS on page 97.

V-BELT

Winter operation

At the beginning of the winter season, have the coolant checked for anti-freeze concentration. If you have to add, only use quality phosphate-free anti-freeze containing ethylene glycol which is available at your Volkswagen dealer.

The ratio between water and anti-freeze depends on the anticipated outside temperatures.

Tension checking

Correct V-belt tension is important for overall vehicle performance.

Tensioning and replacing of vehicle V-belts should be performed by your Volkswagen dealer or a qualified workshop.

See page 147 for V-belt designation.

WARNING

To prevent personal injury stay well clear of the V-belt when the engine is running. Before checking V-belt tension turn the engine off and let it cool down. Hot components can burn skin on contact.

Always heed WARNINGS on page 97.

BRAKE FLUID



Brake fluid reservoir

The brake fluid reservoir is located under the instrument cluster in the dashboard panel.

To gain access to the reservoir, grasp the two recesses provided on back of the frame cover and pull up.

When replacing the cover, insert the front edge first, then press the cover down firmly. Make sure it is correctly seated.

Checking fluid level

The correct fluid level is important for the proper functioning of the brake system. The fluid level in the brake fluid reservoir should always be between the MAX and MIN markings. Your brake fluid level is

automatically monitored by the brake warning light (see page 43).

The fluid level may drop slightly after some time due to the automatic adjustment of the brake pads. This is no cause for alarm.

If the brake fluid level falls considerably below the mark "MIN", the brake warning light will come on. Do not continue to operate the vehicle. The complete brake system should be thoroughly checked by your Volkswagen dealer and the cause corrected.

WARNING

■ **Brake fluid is poisonous. Brake fluid is also harmful to the paint of your vehicle.**

When adding or replacing brake fluid, make certain to avoid spilling. Brake fluid will damage fabric, paint, plastics and metal. Cover the areas surrounding the reservoir before removing the filler cap.

■ **If brake fluid must be added to the reservoir, use only new and unused DOT 4 brake fluid that meets SAE specification J 1703 and conforms to Federal Motor Vehicle Safety Standard 116.**

■ **Do not use any other brake fluid, or brake fluid that has absorbed moisture from the open air, or brake fluid that is dirty. It may cause premature wear or unreliable braking action.**

■ **Do not add or mix DOT 5 silicone type brake fluid with the brake fluid in your vehicle as severe component corrosion may result. Such corrosion could lead to brake system failure.**

Changing brake fluid

Brake fluid absorbs moisture from the atmosphere. If the water content in the brake fluid is too high, corrosion in the brake system may result after a period of time. The boiling point of the brake fluid will also decrease considerably. If the brakes are under constant and extreme use, a vapor lock may result impairing the effectiveness of the brakes and the vehicle safety.

WARNING

The brake fluid must be replaced every 2 years. Your Volkswagen dealer will perform this service for you.

Always heed WARNINGS on page 97.

BATTERY

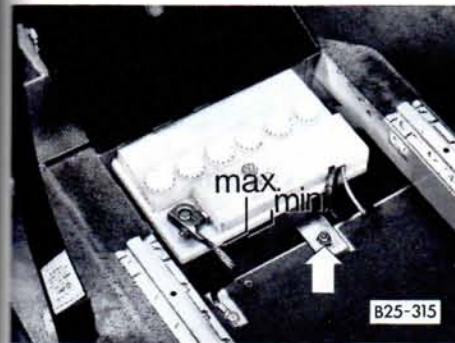
**Auxiliary battery***

The auxiliary battery is located under the left seat. Push the seat all the way forward to gain access to the battery.

The auxiliary battery supplies power when the vehicle is stationary. A special relay between the vehicle battery and the auxiliary battery prevents the vehicle battery from discharging. This way, you still have power to start your vehicle. While driving, both the vehicle battery and the auxiliary battery are charged.

The battery is located under the front passenger seat. To check the battery, move the seat all the way forward.

On vehicles with swivel seats, turn the seat 180° (half circle) and then push forward.

Battery acid level

Under normal operating conditions, the battery in your Volkswagen is maintenance-free.

At high outside temperatures it is advisable, however, to check the fluid level at regular intervals through the transparent battery housing. The fluid level should always be between the "min" and "max" marks in each cell.

If the fluid level is below the "min" mark, let your Volkswagen dealer correct the condition.

WARNING

- Always shield your eyes and avoid leaning over the battery whenever possible.
- Do not let battery acid come in contact with skin, eyes, fabric, or painted surface.
- If you get battery acid in your eyes or on your skin, immediately rinse with cold water for several minutes and call a doctor.
- Do not expose the battery to an open flame or electric spark. Hydrogen gas generated by the battery can explode and cause personal injury.

Always heed WARNINGS on page 97.

*where applicable

Winter operation

During the winter months, battery capacity tends to decrease as temperatures drop. Additionally, more power is consumed while starting, and the headlights, heater, rear window defogger, etc., are used more frequently. Curtail unnecessary power consumption, particularly in city traffic or when travelling short distances only. Let your Volkswagen dealer test the battery's capacity before winter sets in. A well charged battery will not only prevent starting problems but will also live longer.

If your vehicle is left standing for several weeks at extremely low temperatures, the battery should be removed and stored where it will not freeze. This will prevent it from being damaged.

When removing the battery, first disconnect both cables (see Charging of Battery), then unscrew the battery mounting.

WARNING

Always keep the battery well out of the reach of children.

Always heed WARNINGS on page 97.

Charging of battery

WARNING

■ **Always shield your eyes and avoid leaning over the battery whenever possible.**

■ **Charge battery in a well ventilated area. Keep away from open flame or electrical spark. Do not smoke. Hydrogen gas generated by the battery is explosive.**

■ **Battery acid that may spill during charging should be washed off with a solution of warm water and baking soda to neutralize the acid.**

■ **If you get battery acid in your eyes or on your skin, immediately rinse with cold water for several minutes and call a doctor.**

■ **Never charge a frozen battery. It may explode because of gas trapped in the ice. Allow a frozen battery to thaw out first.**

■ **Never use a fast charger as a booster to start the engine. This will seriously damage sensitive electronic components, such as relays, radio, etc., as well as the battery charger.**

■ **Fast charging a battery is dangerous and should only be attempted by a competent mechanic with the proper equipment.**

Slow battery charging

WARNING

■ **Heed all WARNINGS and follow instructions that come with your battery charger.**

■ It is not necessary to remove the battery from the engine compartment, and it is also not necessary to disconnect the cables.

■ Make sure the electrolyte level in each cell is between the "min" and "max" marks. If the fluid level is below the "min" mark, let your Volkswagen dealer correct the condition.

■ Connect charger cables.

Charger cables must be connected **POSITIVE (+) to POSITIVE (+)** and **NEGATIVE (-) to NEGATIVE (-)**.

Do not connect or disconnect charger cables while charger is operating to reduce the danger of exploding.

- Switch on charger.

■ Charging rate not over 6 Amp.

Normally, a battery should be charged at no more than 10 percent of its rated capacity.

For example, a charging current of 4.5 Amp. would be used on a battery having 45 Ah. Rated capacity of the battery in your vehicle is listed on the battery housing.

- After charging, turn off charger and disconnect charger cables.

To remove battery from vehicle

- Disconnect negative ground cable.
- Disconnect positive cable.
- Unscrew bolt of holding plate with open end wrench.

To reinstall battery in vehicle

- Place battery in vehicle and tighten bolt of holding plate.
- Reconnect positive cable.

- Reconnect negative ground cable.

WARNING

Do not reverse polarity.

Cleaning terminals and connections

WARNING

■ Before work is done on the electrical system, disconnect the negative ground cable.

■ When working on the battery, be sure not to short circuit the terminals with tools or other metal objects. This would cause the battery to heat up very quickly, which could lead to damage or explosion and personal injury.

The terminals and connections should be kept clean and greased with silicone spray or petroleum jelly. Make sure the ground connection to the body is tight and free of corrosion.

With a disconnected battery the engine must not run because the electrical system will be damaged.

Replacing battery

A replacement battery must have the same specifications and dimensions as the original equipment battery. Specifications are listed on the battery housing. Make sure the replacement battery is installed correctly and securely. See "Removing and reinstalling battery".

VEHICLE CARE

WINDSHIELD / REAR WINDOW WASHER CONTAINER*



The filler cap is located at the left side of the driver's footwell.

Vehicles with rear window wiper and washer have an additional container on the right in the luggage compartment.

The capacities of the containers are:

Windshield washer container	4.3 qt/4.2 liters
Rear window washer container	1.1 qt/1.0 liters

Filling the containers

To fill the container, unsnap cover and unscrew the filler cap. After filling the container, screw the cap on tightly and close cover.



Since clear water is usually not adequate for cleaning the glass, add a cleaning solution to the water.

Use winterized washer solvent during the cold season. It helps to keep your windshield and rear window clean and prevents the fluid from freezing in the winter.

Do not use engine coolant antifreeze or any other solution that can damage the vehicle paint.

Follow the directions on the can for the correct amount to be used.

After filling the container press the cap onto the filler neck.



Adjusting washer jets

When vehicle is stationary, the water should hit the windshield as illustrated.

The washer jet for the rear window should be adjusted so that the fluid hits the glass in the center of the wiped area.

The jets can be adjusted with a needle.

The jets for the **headlight washer system*** can only be adjusted with a special tool. If necessary contact your Volkswagen dealer.

REP

Wipe
provi

Clea
wind
strea
exar
blad

Rep
year
plac

Note

■ C
mat
affe

■ T
do
thin
wip

■ T
or C
mo

* where applicable

REPLACING WIPER BLADES

Wiper blades must be in good condition to provide clear vision.

Clean your wiper blades regularly with a windshield washer solution to prevent streaking. If the blades are very dirty, for example with insects, carefully clean the blades with a sponge or a soft brush.

Replace your wiper blades once or twice a year. See your Volkswagen dealer for replacement blades.

Notes

- Commercial hot waxes applied by automatic car washes have been known to affect the cleanability of the windshield.
- To prevent damage to wiper blades, do not use gasoline, kerosene, paint thinner, or other solvents on or near the wiper blades.
- To prevent damage to the wiper arms or other components, do not attempt to move the wipers manually.

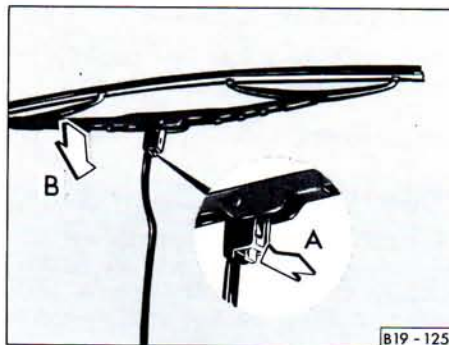

Removing wiper blades

- Raise the wiper arm and hold wiper blade horizontally.
- Depress locking spring (A) and remove blade by pulling it towards the glass (B).

Installing new wiper blades

- The locking spring must click into place on the wiper arm.

VEHICLE CARE

TIRES/WHEELS

New tires

New tires do not possess maximum traction and should be driven at moderate speeds and with caution for the first 100 miles (160 kilometers).

Tire traction

WARNING

When driving on wet or slushy roads, a wedge of water may build up between the tires and the road. This phenomenon is known as aquaplaning or hydroplaning and may cause partial or complete loss of traction, vehicle control or stopping ability. Always reduce speed on wet roads.

Tire service life

The service life of your tires depends for the most part on the following factors:

Tire pressures

WARNING

■ Incorrect tire pressures cause increased tire wear and adversely affect road holding of the vehicle, leading to loss of control and personal injury.

■ Incorrect tire pressures can also lead to sudden deflation, resulting in an accident and personal injury.

Check your tire pressures twice a month, and especially before taking a long trip. Be sure not to forget to check the spare tire. Always check tire pressures when the tires are cold. When the tires are warm, the pressure will be higher. Do not reduce the pressure of warm tires.

Use an accurate tire pressure gauge when checking inflation pressures. Do not exceed the maximum tire inflation pres-

sure listed on the tire sidewall. Cold tire inflation pressure means: when a vehicle has been standing for at least 3 hours or driven for less than 1 mile.

Always include the spare tire during a pressure check.

Driving habits

Fast cornering, heavy acceleration and hard braking all increase tire wear.

Wheel balancing

The front wheels on new vehicles are balanced. When driving, however, various conditions can cause a wheel to become unbalanced. This may be noticed as vibrations in the steering.

Since tire imbalance can cause wear on the steering, suspension and tires, you should have your wheels rebalanced. A wheel should always be balanced if a new tire has been mounted or a tire was repaired.

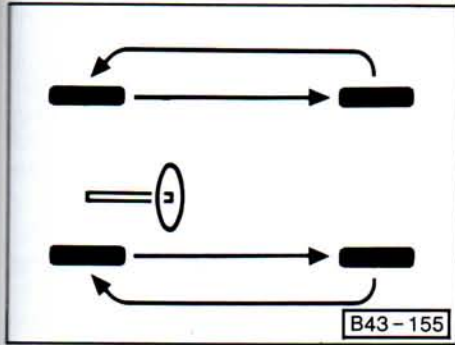

Tire rotation

If the rear tires are worn more than front tires, we recommend that you rotate the rear tires with the front tires as shown in the illustration. By doing this, all tires will have approximately the same service life.

Tires should always remain on same side of vehicle

After rotation adjust tire pressure and torque wheel bolts/lug nuts diagonally to 130 ft lb/180 Nm. Refer to "Changing a wheel" on page 125 for details.



Tire wear

The original tires on your vehicle have built-in wear indicators. They are molded into the bottom of the tread grooves and will appear as approximately 1/2 inch (12 mm) bands when the tire tread depth wears down to 1/16 inches (1.6 mm). Depending on the tire manufacturer, there are six to eight wear indicators evenly spaced around the circumference of the tire. Markings on the sides of the tires (e.g. the letters "TWI" or a triangle) show the locations of the wear indicators.

When the indicators appear in two or more adjacent grooves, it is time to replace the tires. We recommend, however, that you do not let the tires wear down to this extent. Worn tires cannot grip the road surface properly, and are even less effective on wet roads.

WARNING

■ Do not drive with worn tires or tires showing cuts, bruises or other damage because they may lead to sudden deflation causing loss of vehicle control and personal injury.

■ Since worn tires do not grip the road surface properly when driving on wet roads, the vehicle may tend to aquaplane sooner. We strongly urge you to replace your tires when the remaining tread depth is .12 inches (3 mm).

Incorrect wheel alignment

Incorrect wheel alignment causes excessive and uneven tire wear impairing the safety of the vehicle. If you notice excessive tire wear, contact your Volkswagen dealer.

Tire care

Inspect your tires at least every 2,000 miles (3,000 km) for wear and damage.

WARNING

■ **Avoid damaging tires and wheel rims. If you must drive over a curb or other obstacle, drive slowly and at an angle. Frequently check tires for uneven wear and damage.**

■ **Remove imbedded material.**

■ **Replace worn or damaged tires immediately.**

■ **Replace missing valve dust caps.**

■ **Keep oil, fuel, brake fluid, etc. away from tires.**

■ **Keep tires inflated correctly.**

■ **Mark tires before removing them. Remount tires on the same vehicle side because the rotation direction should stay the same.**

■ **Store removed tires in a cool, dry and preferably dark place. Tires which are not on wheels should be stored standing up.**

Tires age even if they are not being used. Tires which are older than 6 years should only be used cautiously in an emergency.

Wheels and tire replacement

Wheels and tires approved by the manufacturer have been specially matched to your vehicle and contribute largely to the road-holding and driving characteristics of the vehicle.

■ **Fitting and repairing tires requires expert knowledge and special tools. This work should only be performed by a specialist.**

■ **For safety reasons, tires should be replaced in pairs and not individually. The tires with the deepest tread should always be mounted on the front wheels.**

■ **In the interest of maximum safety and best all-around vehicle handling, always buy replacement radial tires that have the same specifications with regard to tire size, design, load carrying capacity, tread pattern, tread depth etc. This also applies to Volkswagen recommended alternate replacement tires.**

■ **Never mount used tires if you are not sure of their previous history.**

■ **Whenever replacing a tubeless tire, always install a new valve stem. Tire repair should only be performed by a specialist.**

WARNING

■ **Never mix tires of different design such as steel belted radials with radial bias belted or bias ply tires etc. Mixing tire types will adversely affect road holding and can lead to loss of vehicle control and personal injury.**

■ **New tires do not possess maximum traction. They tend to be slippery. Break new tires in by driving cautiously at moderate speed for the first 100 miles (160 kilometers).**

Applies additionally to the Syncro:

All four wheels on the vehicle must always have tires of the same size, construction and tread type so that the viscous coupling does not abnormally activate the front wheel drive. Different tires on the front or rear wheels exert additional stress on the drive train components, causing increased tire wear and impair vehicle control.

General notes

The original equipment tires and wheel rims on your vehicle comply with all applicable Federal Motor Vehicle Safety Standards.

If you wish to equip your vehicle with tires or wheels other than those installed at the factory, please note the following:

■ If you plan to install other than the original equipment tires and wheel rims, ask your Volkswagen dealer.

■ For technical reasons it is not possible in every case to use wheels from other vehicles – under certain conditions not even wheels from the same vehicle model.

■ Wheel rims and wheel bolts or lug nuts are matched to fit your Volkswagen.

■ When installing different wheels (for example, wheels with winter tires), the correct wheel bolts or lug nuts with the proper length and conical shape must be used. The secure fit of the wheels and the proper functioning of the brake system are dependent upon this.

■ Using tires and/or wheels which have not been approved by the manufacturer for your vehicle type can be detrimental to vehicle safety.

■ If wheel trim discs or a front spoiler are installed, make sure the air flow for cooling the brakes is not obstructed.

■ Before you plan on exchanging steel wheels, light alloy wheels, or snow tires already mounted on wheel rims, consult your Volkswagen dealer. He has the technical information necessary to advise you which wheel rims and wheel bolts or lug nuts are compatible with the original factory installations.

WARNING

■ The use of the wheel rims and wheel bolts or lug nuts that do not meet specifications of the original factory installed equipment will affect the safe operation of your vehicle and may cause an accident and personal injury.

Tire specifications

Tire specifications are imprinted on the sidewall of the tires. If in doubt, check with your Volkswagen dealer.

All passenger car and some light trucks tires must conform to Federal Safety Requirements in addition to these grades.

Treadwear

The treadwear grade is a comparative rating based on the wear rate of the tire when tested on a government test course. For example, a tire graded 150 would wear one and a half (1½) times as well as a tire graded 100. The relative performance of tires depends on actual conditions of use, however, and may depart significantly from the norm due to variations in driving habits, service practices and differences in road characteristics and climate.

Traction A, B, C

The traction grades, from highest to lowest, are A, B and C and represent the tire's ability to stop on wet pavement as measured on government test surfaces of asphalt and concrete. A tire marked C may have poor traction performance.

WARNING

The traction grade is based on braking (straightahead) traction tests and does not include cornering (turning) traction.

Temperature A, B, C

The temperature grades A (the highest), B and C, represent the tire's resistance to the generation of heat. Sustained high temperatures can reduce tire life, and lead to sudden tire failure. Grade C corresponds to a performance which all passenger car tires must meet under the Federal Motor Vehicle Safety Standard No. 109. Grades B and A represent higher levels than the minimum required by law.

WARNING

The temperature grade for this tire is established for a tire that is properly inflated and not overloaded. Excessive speed, underinflation, or excessive loading, either separately or in combination, can cause heat buildup, possible tire failure, loss of control and personal injury.

Snow tires

The tires for your vehicle were selected for optimal performance under normal driving conditions.

For winter driving, the roadability of your vehicle can be improved by installing all season tires or radial snow tires (M + S) with or without studs¹⁾.

That applies also to the Syncro – see page 78.

When installing snow tires, please note the following:

- Only radial ply snow tires must be installed. Ask your Volkswagen dealer for the recommended tire size.
- Snow tires should be mounted on all four wheels.
- The tire pressures for snow tires are the same as for summer tires. However, do not exceed the maximum tire pressure listed on the sidewall.
- Snow tires should have the same load capacity as original equipment tires and should be mounted on all four wheels.

■ Snow tires do not fulfill their purpose, if the tread depth is less than $\frac{5}{32}$ in (4 mm).

WARNING

■ Tires with badly worn treads and studs are very dangerous. Make sure they are replaced immediately.

■ Never mix tires of different design such as steel belted radials with radial bias belted or bias ply tires etc. Mixing tire types will adversely affect road holding and can lead to loss of vehicle control and personal injury.

■ Snow tires with studs should be run at moderate speeds when new in order to give the studs time to settle.

Do not drive a vehicle equipped with snow tires at prolonged high speed. Snow tires do not have the same degree of traction on dry, wet or snowfree roads as a normal tire. Furthermore, snow tires wear rapidly under these conditions.

■ Where snow tires are compulsory on certain roads, this also applies to vehicles with all-wheel-drive.

¹⁾ Check with your local Motor Vehicle Bureau for possible restrictions.

Snow chains

Snow chains can be used on the rear wheels only.

Only use chains with fine pitch links protruding no more than 1/2 in/15 mm from tire tread and side walls, including tensioner. Wheels must rotate freely in all steering positions with chains mounted to prevent damage to body, axle or brake components. **Drive slowly and follow the chain manufacturer's instructions.**

Remove chains when roads are free of snow. Otherwise, they can be damaged and impair vehicle handling.

Syncro models only

Conventional snow chains may not be used with 205/70 x 14 tires on 5 1/2 J x 14 wheels which are mounted on your vehicle. The use of conventional snow chains is only possible on smaller tires (e.g. 185 R 14C). Ask your VW dealer.

Where possible, snow chains should be fitted to all four wheels. If only two chains are available, these must be fitted to the rear wheels.

Cable type chains may also be fitted on all standard tires and wheels (including 205/70 x 14 tires on 5 1/2 J x 14 wheels), however, they should only be used when road conditions require them. Always remove snow chains when road conditions improve. Be sure to follow all state and local regulations pertaining to the use of snow chains.

WARNING

To prevent personal injury, wear protective gloves when fitting cable chains on your wheels. Always follow the instructions of the manufacturer.

DIFFICULT OPERATING CONDITIONS

Driving under difficult conditions

The vehicle construction and equipment is designed for normal operating conditions. This also applies to the frequency and the extent of service requirements as stated in the Maintenance brochure.

If you are planning to drive your vehicle under difficult operating conditions (for example, continuous trailer towing, very hot or cold weather, very dusty conditions, poor fuel quality etc.) you may want to make special preparations such as changing to appropriate oil viscosity, having your car thoroughly inspected. Furthermore, the maintenance should be matched to the operating conditions (see page 95).

Operating your vehicle outside the USA or Canada

Government regulations in the United States and Canada require that automobiles meet specific emission regulations and safety standards. Therefore, vehicles built for the USA and Canada differ from vehicles sold in other countries.

If you plan to take your vehicle outside the continental limits of the United States or Canada, there is the possibility that

- unleaded fuels for vehicles with catalytic converter may not be available;
- fuel may have a considerably lower octane rating. Improper fuel may cause engine damage;
- service may be inadequate due to lack of proper service facilities, tools or testing equipment;
- replacement parts may not be readily available.

Volkswagen cannot be responsible for mechanical damage that could result because of inadequate fuel, service or parts availability.

Certain Volkswagen models are available for delivery in Europe under our tourist delivery and return shipment program.

For details consult your Volkswagen dealer or write to:

USA Volkswagen United States, Inc.
Tourist Delivery
P.O. Box 3951
Troy, NJ 08067-3951

Canada Volkswagen Canada, Inc.
Tourist Delivery
1940 Eglinton Avenue East
Scarborough, Ontario
M1L 2M2

If you bought your vehicle abroad and want to bring it back home, be sure to inquire about shipping and forwarding requirements, as well as current import and customs regulations first.

Make sure the vehicle meets United States emission regulations and safety standards. Otherwise it may prove too costly or even impossible to add the equipment necessary to bring the vehicle into compliance with these regulations and standards.

Canadian regulations require that any car not complying to standards has to be shipped back to the car's country of origin at the owner's expense.

WINTER DRIVING

Remember the following points when driving in the winter:

■ Winter weather is particularly hard on the battery. We recommend having the battery checked, preferably by a Volkswagen dealer, before the cold weather starts – see page 110.

If the vehicle is left standing for several weeks at extremely low temperatures, the battery should be removed – see page 111 for further details.

■ Have the antifreeze concentration in the cooling system checked before the cold weather starts – see page 107.

■ The engine oil must have the correct viscosity grade for the outside temperatures to be expected – see page 98.

■ The best way to protect the bodywork is to wash and wax it frequently, especially in winter – see page 90.

■ Always use a windshield washer fluid with antifreeze for the windshield and rear window washer system in winter – see page 112.

■ Use a scraper to remove snow and ice from the windows – see page 91.

■ On winter roads the use of winter tires or all-weather tires will improve handling; this also applies to vehicles with all-wheel drive – see pages 78 and 118.

■ When driving in the mountains in winter it is best to take along a set of snow chains. Snow chains may be compulsory for some mountain roads, and this restriction also applies to vehicles with all-wheel drive – see pages 78 and 119.

VEHICLE CARE

ADDITIONAL ACCESSORIES, MODIFICATIONS AND PARTS REPLACEMENT

The Volkswagen Vanagon/Transporter incorporates the latest safety design features ensuring a high standard of active and passive safety. This safety could be impaired by any non-approved changes to the original new-car condition. For this reason, please observe the following points when installing additional accessories, if parts have to be replaced or if any modifications are made to the vehicle:

■ **Always consult** an authorized Volkswagen dealer **before** purchasing accessories and **before** any modifications are carried out.

■ **In your own interest, you are advised to use only expressly approved Volkswagen accessories and genuine Volkswagen spare parts.**

These parts and accessories have been specially evaluated with respect to suitability for use with the Volkswagen Vanagon/Transporter.

■ Approved Volkswagen accessories and genuine Volkswagen parts are available from authorized Volkswagen dealers. Volkswagen dealers also have the necessary facilities to install the parts properly.

JAC

The
chang
the dr

On v
store

The s

JACK AND TOOLS

The jack and the tools necessary to change a wheel are in a bag stored under the driver's seat.

On vehicles with swivel seats they are stored under the rear seat bench.

The screwdriver has a reversible blade.

WARNING

■ Use the jack only for changing a wheel. Never use the jack to lift other vehicles or other loads as this may lead to accidents and personal injury.

■ The jack must never be used as a support to work underneath the vehicle. If the jack is accidentally dislodged, you could be seriously injured.

■ Do not raise the vehicle using a bumper jack. The bumper system would be damaged. Also, the jack may slip which could cause personal injury.

■ Do not support your car on cinder blocks, bricks or other props that may crumble under continuous load.

■ Do not start or run the engine while the vehicle is supported by the jack.

■ When working under the vehicle, always use safety stands specifically designed for this purpose.

DO-IT-YOURSELF-SERVICE

SPARE WHEEL

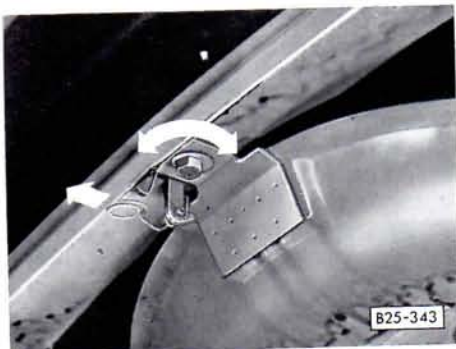

The spare wheel is located underneath the floor panel of the driver cab, where it rests on a hinged metal plate.

- To take out the spare wheel, remove the bolt (curved arrow) from the holding bracket with wheel wrench.

WARNING

Keep hands and arms away from underbody of vehicle.

- Stand in front of the vehicle and pull the catch hook (arrow) forward to let the metal plate drop.
- Pull out the spare wheel.

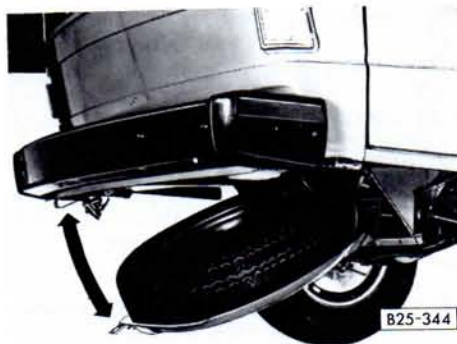

- When re-installing the spare wheel, slide spare wheel onto metal plate.
- Give the plate a hard upward push and make sure the catch hook is securely engaged.
- Replace bolt and tighten firmly.

WARNING

Never drive the vehicle without a firmly tightened bolt on the holding bracket. Should the catch hook disengage accidentally, you could lose control of the car.

Check the inflation pressure periodically to keep the tire ready for use.

WARNING

Under no circumstances should you store the spare wheel unsecured in the luggage compartment. This could cause serious personal injury to passengers in the vehicle in case of a collision.

CHANGING A WHEEL

WARNING

■ If you have a flat tire, move a safe distance off the road. Turn off the engine, the emergency flasher on and use other warning devices to alert other motorists.

■ Passengers must not remain in the vehicle when it is jacked up.

■ Make sure that passengers wait in a safe place away from the vehicle and well away from the roadway and traffic.

■ Before you change a wheel, be sure the ground is level and firm. If necessary, use a board under the jack.

■ Set the parking brake and block the wheel opposite the defective wheel on the other side of the vehicle. Engaging a gear or placing the Automatic transmission selector lever in P (Park) position is not a substitute for fully setting the parking brake.

**Step 1**

■ Take out the bag with jack and tools from under the driver's seat.

Step 2

■ With the wheels still firmly resting on the ground, remove the hub cap/wheel cover of the defective wheel.

**Wheels with wheel cover**
(left illustration)

■ The wheel cover can be pulled off with puller clip and lug wrench.

Wheels with hub cap
(right illustration)

■ Remove chrome plated hub cap with puller clip and lug wrench. Insert clip in holes at rim of a hub cap. Put wheel wrench through clip, brace one end of wrench on wheel rim and pull lightly on other end.

When you place the hub cap face down, you can use it as a tray for lug bolts (front wheels) or lug nuts (rear wheels).



Step 3

■ Loosen wheel nuts or bolts counterclockwise about one turn with the lug wrench. **Do not yet remove the nuts or bolts.**

To loosen – turn counterclockwise

To tighten – turn clockwise

Step 4

There are two jack ports on each side under the car body for front and rear wheel changing – see right illustration.

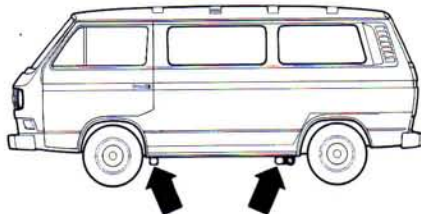

WARNING

■ **Mounting the jack at any other place may damage the car or may result in personal injuries.**

■ **Provide a firm base for the jack on the ground. If necessary, use a board.**

■ Securely insert the jack into the jack port closest to the wheel to be changed.

■ Before inserting jack, clear jack port.

■ Place jack as straight as possible, as shown.

Step 5

Never jack the vehicle up by the bumper or body.

Do not raise the vehicle until you are sure the jack is securely engaged.

Passengers must not remain in the vehicle when jacked up.

■ **Make sure that passengers wait in a safe place away from the vehicle and well away from the roadway and traffic.**

■ **To raise the vehicle, turn the handle clockwise.**

Only raise the vehicle as much as is needed to change a wheel.

Step 6

WARNING

Before installing the spare wheel, accumulated road dirt must be removed from the inside and outside of the wheel nut/bolt holes to assure a secure mount on front hub or rear drum.

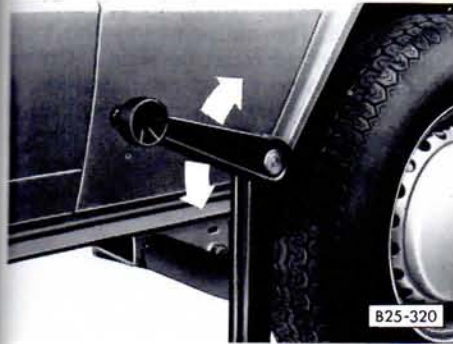

■ Fully unscrew wheel nuts or bolts and place them into the hub cap. Take the top nut or bolt off last. Place the spare wheel against the wheel hub and slightly rotate the wheel until a bolt hole in the wheel is in line with a threaded stud in the wheel hub. Reinstall nuts or bolts and tighten them crosswise by hand before jacking the car down.

Step 7

■ **To lower** the vehicle, turn the handle counterclockwise.



Step 8

■ Then go crosswise from one nut or bolt to another tightening them firmly with the lug wrench.

■ **Correct tightness of the wheel nuts is important.**

■ Correctly tightened nuts or bolts should have a torque of 130 ft lb/180 Nm. This torque can be obtained with the lug wrench by any person of average strength. If in doubt about the correct tightness of the wheel nuts, have them checked with a torque wrench by your dealer or at service station.

Step 9

■ To install the hub cap, place it around the lower part of the wheel center. With a firm blow of your hand on the upper part, the hub cap will snap into place. Make sure it is firmly seated.

Step 10

■ Fully lower the vehicle and remove jack.

■ Correct the air pressure of the tire you have just put on. For correct tire inflation pressures, see the sticker on the left door-jamb.

■ Store the jack and tools under the driver's seat.

■ Store damaged tire in spare wheel metal plate under front of vehicle.

■ Engage lock for metal plate and firmly secure plate with bolt.

■ Have flat tire repaired and replaced promptly.

FUSES

A failure in the electrical system may be caused by a burned fuse.

Fuses are arranged in one centralized unit. The unit is located on the left side under the dashboard behind a cover.

Removing cover:

Detach cover at front, swing downwards and take it off.

Installing cover:

Hang cover in the eyes of fuse box bracket, swing it upwards and press it firmly into position.

Replacing a fuse

Before replacing a fuse, turn off all lights and accessories and remove the ignition key to avoid damaging the electrical system.

■ Consult the fuse listing on the following page to find out which fuse belongs to the component that has failed.

■ Remove blown fuse with the plastic clip located on cover in front of fuse box.

Three spare fuses can be attached to the bottom of the fuse panel. It is good planning to keep a supply of spare fuses on hand. They are available at your Volkswagen dealer.

■ Replace the blown fuse which can be recognised by the burnt metal strip, with a fuse of equal ampere rating.

If a fuse blows repeatedly, do not keep on replacing it. The cause of the short circuit or overload must be found. On no account should fuses be patched up with tin foil or wire as this may cause serious damage elsewhere in the electrical circuit or cause a fire.

WARNING

Do not use a fuse of higher amperage, because this could damage the electrical part and fire can result.

DO-IT-YOURSELF-SERVICE

REPLACING BULBS

Before starting to replace a bulb, switch off the respective circuit.

Do not touch the glass part of the new bulb with bare fingers. Finger prints left on the glass evaporate when the bulb gets hot, the vapor settles on the reflector surface and dims it.

Always use the same type of bulb. The designation is marked on the bulb.

It is advisable to always carry a box of spare bulbs in the vehicle. Bulbs can be obtained from any VW dealer.

It should contain, at least, the following bulbs which are important for traffic safety:

- 12V/70/50W – Headlight
- 12V/21/5W – Front turn signal and front side marker light
- 12V/21W – Rear turn signal
- 12V/3W – Rear side marker light
- 12V/21/5W – Brake and tail lights
- 12V/4W – Licence plate light



Headlights

The outer units are for low and high beams and have two filaments. The auxiliary driving lamps are for high beam only and have one filament.

Should it become necessary to replace a headlight bulb, the air intake grille must be removed first.

- With a screwdriver loosen the five quick-release screws along upper edge of grille.
- Pull the grille slightly toward you.
- Then lift the grille out of its retainer.

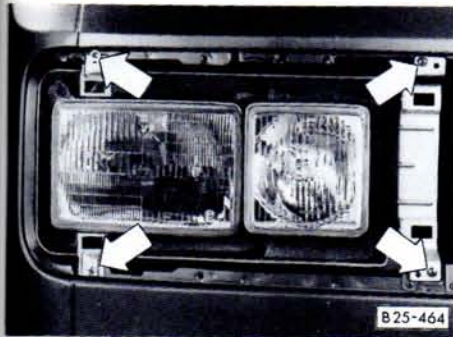

- Remove the four screws (arrows) and take the headlight out.

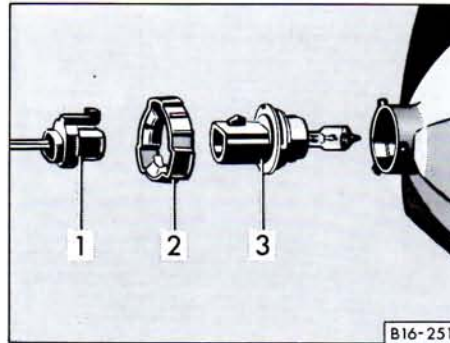

Outer headlights

- Disconnect wire connector (1)
- Twist lock ring (2) counterclockwise, pull bulb (3) out of headlight housing and discard.
- Install new bulb so that the locating lugs on the headlight housing engage the recesses on the bulb.
- Reinstall lock ring so that its recesses engage the locating lugs on the headlight housing.
- Twist lock ring clockwise until firmly seated.
- Reconnect wire connector. Have headlight beam alignment checked.

Auxiliary driving lamps

- Turn cap to left and take off.
- Pull wire connector off.
- Unhook spring clip holding bulb and swing it away.
- Take bulb out and insert new bulb so that the locating lug on bulb plate engages recess in reflector.
- Swing spring clip over bulb plate. Squeeze clip together and engage it in the retaining lugs.
- Attach wire again.
- Install cap and turn to right.
- Have headlight setting checked.



B25-323

Front turn signal / parking light bulb / front side marker light bulb

- Remove the two Phillips screws and take off the lens cover.
- Pull out bulb holder and push down the rubber boot.
- Press spring clip inward and take out bulb holder.
- Give bulb a left turn and remove.
- Replace bulb and reverse the above procedure to install bulb holder and lens cover.

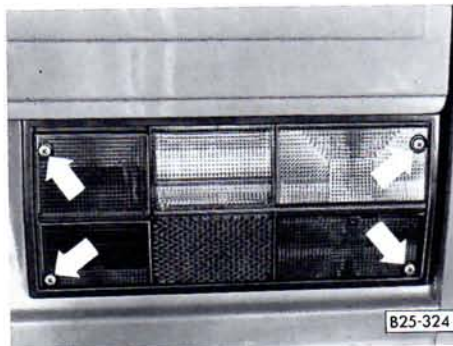

B25-324

Rear turn signal, stop / tail / back-up light bulb

- Remove the four Phillips screws and take off lens cover with bulb housing.

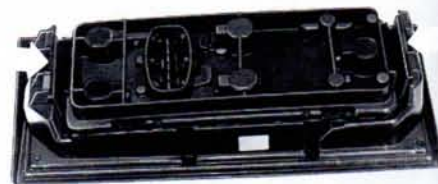

B25-325

- Squeeze the two side springs inward (arrow) and lift out the bulb housing.
- Press defective bulb into bulb holder, turn left and take out bulb.
- Replace bulb and reverse the above procedure to install bulb housing with lens cover.

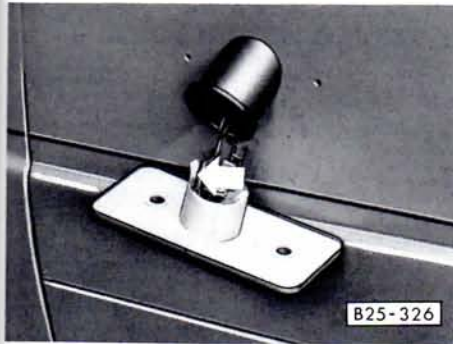

Rear side marker bulb

- Remove the two Phillips screws and take off lens cover.
- Pull out bulb holder and push down the rubber boot.
- Press spring clip outward and take out bulb holder.
- Give bulb a right turn and remove.
- Replace bulb and reverse the above procedure to install bulb holder and lens cover.



Interior light

- To remove lamp, press against spring clip on left side and lift out the housing.
- Take out bulb from between the two spring contacts and install new bulb.
- Install lamp by inserting switch side of housing into cut-out first.
- Then press in the other side until spring clip engages.

License plate light bulb

There is one bulb housing on each side of the license plate. Only if both bulbs are operative is the license plate properly illuminated.

- Take the bulb housing off by pulling it down.
 - Remove the two Phillips screws and take off lens cover.
 - Press bulb into housing, turn left and take out.
 - Replace bulb and reverse above procedure to install bulb housing and lens cover.
- Make sure the spring clip on each side of the housing is securely engaged in the cutouts provided at upper edge of cross panel.

DO-IT-YOURSELF-SERVICE

HEADLIGHT ADJUSTMENT

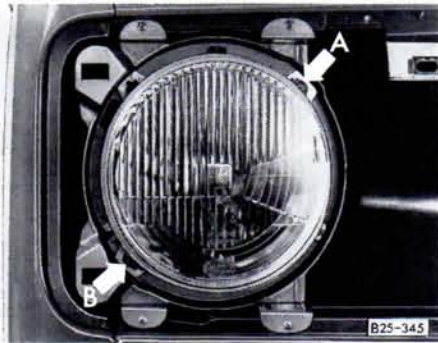

The proper headlight adjustment is very important for traffic safety. The headlight adjustment should therefore only be done with a special appliance.

Adjust the headlight using the Phillips screwdriver from the vehicle tools.



The illustration show the adjustment on the right headlights. On the left headlights the adjustment are symmetrically opposite.

A – lateral adjustment
B – height adjustment

To reduce the beam range, turn the screwdriver clockwise.

INSTALLING / REPLACING A RADIO

If you wish to install a radio or replace the factory installed radio*, please note the following:

■ The factory installed connectors* are designed for Original Volkswagen Radios.

When installing a different radio, difficulties could arise such as:

- the radio may not fit into the provided space
- the electrical connections may not be compatible
- different connector terminals may be needed.

■ Therefore, we recommend that you have your authorized Volkswagen dealer install or replace the radio. They are the most familiar with the technical features of your vehicle. They also offer Original Volkswagen Radios with the necessary installation components and instructions.

WARNING

Improperly installing a radio could risk a short circuit. This could result in an electrical fire.

*where applicable

DO-IT-YOURSELF-SERVICE

EMERGENCY STARTING

Starting by pushing or towing

Vehicles with Automatic Transmission cannot be started by pushing or towing.

Vehicles with Manual Transmission must not be started by pushing or towing.

Damage to the catalytic converter and/or other parts of the vehicle may result.

Starting with jumper cables

WARNING

■ **Always shield your eyes and avoid leaning over the battery whenever possible.**

■ **Do not allow battery acid to contact eyes or skin. Flush any contacted area with water immediately.**

■ **Improper use of booster battery to start a vehicle may cause an explosion.**

■ **Vehicles batteries generate explosive gases. Keep sparks, flame and lighted cigarettes away from batteries.**

■ **Do not charge a frozen battery; allow it to thaw out first. Gas trapped in the ice may cause an explosion.**

■ **Do not try to jump start any vehicle with a low electrolyte level in the battery.**

■ **The voltage of the booster battery must also have a 12-volt rating. The capacity (Ah) of the booster battery should not be lower than that of the discharged battery. Use of batteries of different voltage or substantially different Ah rating may cause an explosion and personal injury.**

■ **Applying a higher voltage booster battery will cause expensive damage to sensitive electronic components, such as relays, radio, etc. . .**

■ **Vehicle with discharged battery: turn off lights and accessories, move lever to N or P (Automatic transmission) or into Neutral (Manual transmission) and set parking brake.**

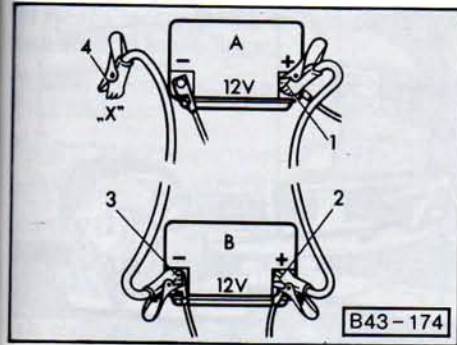

B43-174

- A – Discharged battery
 B – Booster battery
 X – To bolt securing ground strap to body

Use of jumper cables

WARNING

■ To avoid serious personal injury and damage to the vehicle, heed all warnings and instructions of the jumper cable manufacturer. If in doubt, call for road service.

■ The jumper cables must be long enough so that the vehicles do not touch.

■ When connecting jumper cables, make sure that they cannot get caught in any moving parts in the engine compartment.

Improper hook-up of jumper cables can ruin the alternator.

Always connect

POSITIVE (+) to POSITIVE (+), and NEGATIVE (-) to bolt securing ground strap to body.

1. Connect clamp of plus-cable to positive (+) terminal (1) of discharged battery.
2. Connect clamp on opposite end of cable to positive (+) terminal (2) of booster battery.
3. Connect clamp of minus-cable to negative (-) terminal (3) of booster battery.

4. Connect clamp on opposite end of cable to a bare metal part bolted directly to bolt securing ground strap to body (4) of vehicle with discharged battery. Connect clamp as far away from battery as possible.

5. Start the engine of the vehicle with the booster battery. Run the engine at a moderate speed.

6. Start engine with discharged battery in the usual manner. If engine fails to start, do not continue to crank but contact nearest workshop.

7. With engine running, remove jumper cables from both vehicles in exact reverse order: Steps 4 through 1.

Always heed WARNINGS on page 97.

GAS STATION INFORMATION

EMERGENCY TOWING WITH COMMERCIAL TOW TRUCK

The following information is to be used by commercial tow truck operators who know how to operate their equipment safely.

General hints

- Whenever possible, tow with front wheels off ground.
- Vehicle may be lifted in rear and moved to position for front hook-up.
- The Vanagon cannot be towed with conventional sling-type equipment. Towing with this type of equipment will cause bumper and body panel damage.

Vanagon with Automatic Transmission

Tow with dollies under rear wheels or on flat bed truck to avoid damage to automatic transmission.

WARNING

Never allow passengers to ride in a towed vehicle for any reason.



Front Hook-up

- Attach wheel lift equipment to wheels.
- Attach safety straps to wheels.
- Attach safety chains to axle platform.
- Towing clearance: 6–12 inches between tires and ground.
- Towing Speed/Miles:
 - Automatic Transmission – 30 mph/30 mi
 - Manual Transmission – 50 mph/50 mi.

- Attach safety chains on axle platform – **not around brake lines.**

Towing clearance: four inches between tires and road.

Towing speed/distance:

Automatic Transmission – 30 mph/
30 miles (48 kmh/48 km).

Manual Transmission – 50 mph/50 miles
(80 kmh/80 km).

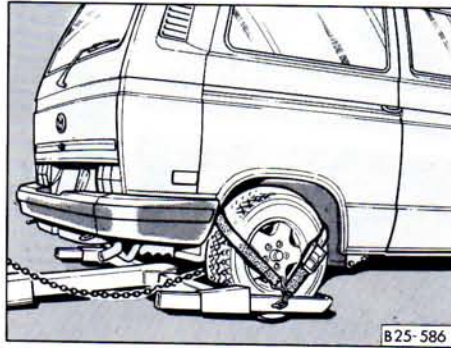

Rear Hook-up

- Attach wheel lift equipment to wheels.
- Attach safety straps to wheels.
- Attach safety chains to trailing arms.
- Towing clearance: 6–12 inches between tires and ground.
- Towing Speed/Miles:
 - Automatic Transmission – 30 mph/30 mi
 - Manual Transmission – 50 mph/50 mi.

Vanagon Syncro

Front and Rear Hook-up

The Vanagon Syncro cannot be towed with conventional sling-type towing equipment nor with wheel lift equipment or wheel dollies to avoid damage to the all-wheel drive system. Use flat-bed tow truck only.

DO-IT-YOURSELF-SERVICE

LIFTING VEHICLE

The vehicle should never be lifted or jacked up from underneath the engine oil pan, the transmission housing, or the front or rear axle. This could lead to serious damage.

The same lifting points as illustrated for the hoist also apply when using a floor jack. To avoid damage to the underbody or chassis frame, it is necessary to insert a rubber pad between the floor jack and the lift points.

Lifting with workshop hoist and with floor jack

Make sure there is sufficient clearance between pads and vehicle before driving vehicle on to hoist.

WARNING

When removing components such as engine block, transmission housing, fuel tank, wheels, front or rear axle, anchor vehicle to hoist or add corresponding weights to maintain the center of gravity. Otherwise the vehicle might tilt or slip off the hoist, causing serious damage or personal injury.



■ To reduce the risk of serious personal injury and vehicle damage, lift vehicle only at the special workshop hoist and floor jack lift points illustrated. Failure to lift vehicle at these points could cause the vehicle to tilt or fall from a lift when, for example, heavy components such as the engine block or transmission are removed resulting in a change in vehicle weight and balance.

■ If you must lift your vehicle with a floor jack to work underneath, be sure the vehicle is safely supported on stands intended for this purpose.



Lifting points

Front

At the front jacking point.

Rear

At rear cross member.

The vehicle must be lifted only at the lift points illustrated.

Lifting with vehicle jack

Refer to the "Changing a wheel" on page 125.

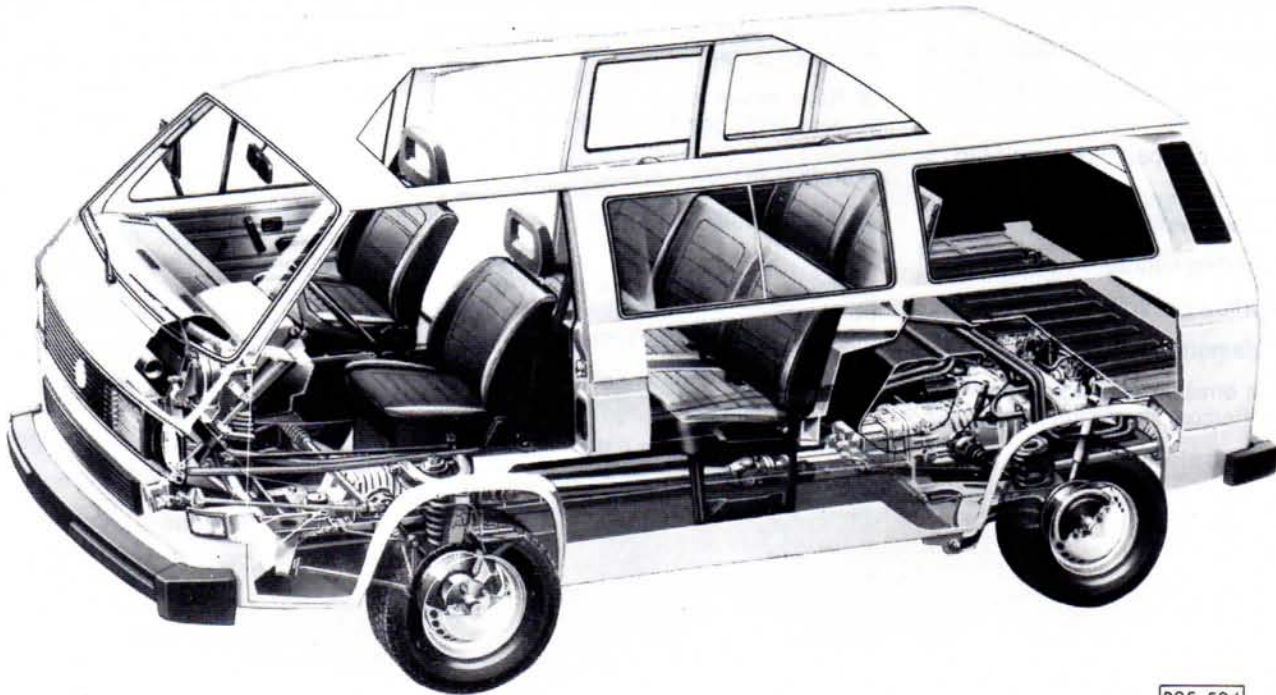

B25-534

Picture shows the Vanagon Syncro.

TECHNICAL DESCRIPTION

ENGINE

- Four stroke gasoline engine in rear.
- Four cylinder horizontally opposed.
- Crankshaft with four main bearings.
- Liquid cooling system, thermostatically controlled.
- Thermostat operated electric fan.
- Pressure oil feed with gear – type pump and full flow filter.
- Self-adjusting hydraulic valve filters.
- AFC (Airflow controlled) fuel injection.
- Paper element air cleaner.
- Exhaust emission control system with activated charcoal filter in the fuel system.
- Breakerless electronic ignition.

MANUAL TRANSMISSION

- Single plate, dry clutch.
- Synchronized four speed transmission and differential in one housing with common lubrication.
- Rear wheel drive, with two constant velocity joints per drive shaft.

Syncro

- Hydraulically operated single plate clutch.
- Baulk synchronised 4-speed manual transmission with additional Low-speed traction gear (4+L transmission).
- Permanent four-wheel drive through viscous coupling.
- Manually operated differential lock for rear final drive available as optional extra.

AUTOMATIC TRANSMISSION

- Hydrodynamic torque converter and planetary gearing with three forward and one reverse gear.
- Final drive in separate housing.
- Rear wheel drive, with two constant velocity joints per drive shaft.

FRONT WHEEL SUSPENSION

- Independent upper and lower control arm
- Stabilizer
- Coil springs
- Shock absorbers

Syncro

- Independent wheel suspension by means of double wishbones with coil springs and telescopic shock absorbers.
- Double jointed shafts
- Stabilizer bar
- Viscous coupling

Steering

- Rack and pinion
- Safety steering column

REAR WHEEL SUSPENSION

- Independent semi-trailing arms with integrated axle support
- Coil springs
- Shock absorbers

Syncro

- Independent wheel suspension by way of diagonal arm axle with coil springs and telescopic dampers.
- Double jointed drive shafts
- Differential lock as optional extra.

BRAKES

- Hydraulic dual-circuit power-assisted brake system with pressure regulator for rear wheel circuit. Front wheels with disc brakes, rear wheels with self-adjusting drum brakes.
- Parking brake for rear wheels.

Body/Chassis

- All steel unitized body
- Frame plates reinforced with side and cross members.

TECHNICAL DESCRIPTION

EMISSION CONTROL SYSTEM

In the interest of clean air

Pollution of our environment has become a problem that is of increasing concern to all of us. We urge you to join us in our efforts for cleaner air in controlling the pollutants emitted from the automobile.

You can make a significant contribution to keeping our air clean by:

- Always using lead free gasoline.
- Not letting your vehicle idle unnecessarily.
- Following the recommended preventive maintenance schedule contained in the maintenance booklet.
- Not removing or altering the emission control system.
- Taking the precautions described below to prevent damage to the emission control system in your vehicle.

Volkswagen warrants the Emission Control System in your new vehicle under the terms and conditions set forth in the Warranty booklet.

Your Volkswagen is equipped with such a system, which contains the following major components.

Catalytic converter

The catalytic converter is an efficient "clean-up" device built into the exhaust system of the vehicle. The catalytic converter burns the undesirable pollutants in the exhaust gas before it is released into the atmosphere.

The exclusive use of unleaded fuel is critically important for the life of the catalytic converter and proper functioning of the engine.

The catalytic converter will be permanently damaged by

- exceeding the "max" marking when adding engine oil (see page 99)
- push or tow starting your vehicle
- misfiring of the engine
- turning off the ignition while the vehicle is moving or
- other unusual operating conditions.

Do not continue to operate your vehicle under these conditions, as otherwise fuel can reach the catalytic converter. This could result in overheating of the converter, requiring its replacement.

For maintenance intervals refer to your Maintenance booklet.

Oxygen Sensor (OXS)

The oxygen sensor, installed in the exhaust manifold, continuously senses the oxygen content of the exhaust and signals the information to an electronic control unit.

Carbon canister

The vehicle is equipped with a carbon canister to prevent fuel vapor from escaping into the atmosphere.

The vapor is passed into the carbon canister, where it is retained when the engine is turned off. When the engine is running, a valve allows air into the canister, and the fuel vapor is passed to the engine for combustion.

The system does not require any maintenance.

To assure efficient operation of the Emission Control System:

- Have your vehicle maintained properly and in accordance with the service recommendations as described in your Maintenance booklet. Lack of proper maintenance as well as improper use of the vehicle will impair the function of the emission control system and could lead to damage.

- Do not alter or remove any component of the Emission Control System unless approved by the manufacturer.

- Do not alter or remove any device, such as heat shields, switches, ignition wires, valves, which are designed to protect your vehicle's emission control system.

- Do not continue to operate your vehicle if you detect engine misfire or other unusual operating conditions.

WARNING

Starting

Do not leave engine idling unattended after starting. If warning lights should come on to indicate improper operation, they would go unheeded. Extended idling also produces heat, which could result in overheating or other damage to the vehicle or other property.

Parking

- Do not park or operate the vehicle in areas where the hot exhaust system may come in contact with dry grass, brush, fuel spill or other material, which can cause a fire.

Undercoating

Do not apply additional undercoating or rustproofing on or near the exhaust manifold, exhaust pipes, catalytic converter or heat shields. During driving, the substance used for undercoating could overheat and cause a fire.

TECHNICAL DATA

ENGINE DATA / SPARK PLUGS

Engine

Maximum output SAE net	90 hp at 4800 rpm
Maximum torque SAE net	117,3 ft lb at 3200 rpm
No. of cylinders	4
Displacement	129 CID (2109 cm ³)
Stroke	2.99 in (76 mm)
Bore	3.70 in (94 mm)
Compression ratio	9.0 : 1
Fuel ¹⁾	Regular unleaded
Spark plugs	
Bosch	W7CC0
Beru	14L-7CU/14L-7C
Champion	N288

¹⁾ Minimum octane rating and further details see page 86.

Notes

Spark plugs are replaced during the Volkswagen scheduled Maintenance service. If you replace the spark plugs between the Volkswagen Maintenance services, the following should be noted:

■ Engine, spark plugs and the ignition system are matched. To avoid faulty operation or engine damage, use only Original Volkswagen spark plugs. It is especially important to note the number of electrodes and heat value.

■ Since spark plug specifications may change for technical reasons during a current model year, we recommend that you obtain your spark plugs from a Volkswagen dealer who has the latest information.

V-BELTS

for waterpump/alternator . 9.5 × 1100 LA
 for A/C compressor . . . 12.5 × 1153 LA
 for power steering 9.5 × 1080

Notes

The V-belts are among the most severely stressed parts of a vehicle. The belts therefore have very high quality requirements.

When replacing a belt, it is not sufficient to use just any belt of the same size. For safe operation, use only Original Volkswagen V-belts specially designed for your vehicle. The correct belts can be obtained at your Volkswagen dealership.

CAPACITIES

Fuel tank	16.0 gal/60 liters
.	Syncro: 18.5 gal/70 liters
Reserve (of total capacity)	2.5 gal/10 liters
Cooling system	18.6 qt/17.5 liters
Automatic transmission fluid (ATF)	3.2 qt/3.0 liters
Windshield washer container	4.3 qt/4.2 liters
Rear window washer container	1.1 qt/1.0 liters
Engine oil	
with filter change	4.8 qt/4.5 liters
without filter change	4.2 qt/4.0 liters
Do not fill above "max" mark. The oil level should be checked while topping up.	
Difference between "min" and "max" marks on the dipsticks is approx. 1 qt/1 liter	

TECHNICAL DATA

DIMENSIONS

	Station Wagon		Kombi		Camp-mobile		Pick-up	
	in	mm	in	mm	in	mm	in	mm
Length	179.9	4570	179.9	4570	179.9	4570	179.9	4570
Width	72.6	1845	72.6	1845	72.6	1845	72.6	1845
Height (unladen)	77.2	1960	77.2	1960	81.6	2075	75.9	1930
Angle of approach	21°		21°		21°		21°	
Angle of departure	19°		19°		19°		19°	
Wheelbase	96.9	2460	96.9	2460	96.9	2460	96.9	2460
Front track	62.4	1585	62.4	1585	62.4	1585	62.4	1585
Rear track	61.8	1570	61.8	1570	61.8	1570	61.8	1570
Ground clearance with gross vehicle weight front	7.5	190	7.5	190	7.5	190	7.5	190
rear	8.0	204	8.0	204	8.0	204	8.0	204
Turning circle diameter	approximately 35 ft/10.7 (wall to wall).							
Ramp angle	22°		22°		22°		22°	

Ground clearance is reduced by approximately 1.2 in (30 mm) on vehicles having a lowered chassis.

When driving up steep ramps, on rough roads, over curbs, etc. it is important to remember that some parts of your car are close to the ground, such as spoilers or exhaust system components. Be sure to avoid damage.

Syncro	Station Wagon		Kombi		Camp-mobile		Pick-up	
	in	mm	in	mm	in	mm	in	mm
Length	179.9	4570	179.9	4570	179.9	4570	179.9	4570
Width	72.6	1845	72.6	1845	72.6	1845	73.6	1870
Height (unladen)	78.3	1990	78.3	1990	82.8	1990	77.2	1960
Angle of approach	22°		22°		22°		22°	
Angle of depature	19°		19°		19°		19°	
Wheelbase	96.6	2455	96.6	2455	96.6	2455	96.6	2455
Front track	61.7	1568	61.7	1568	61.7	1568	61.4	1560
Rear track	61.4	1560	61.4	1560	61.4	1560	61.4	1560
Ground clearance with gross vehicle weight front	8.5	215	8.5	215	8.5	215	8.5	215
rear	7.6	193	7.6	193	7.6	193	7.6	139
Turning circle diameter	approximately 36 ft/10.9 (wall to wall).							
Wading depth	11.3	290	11.3	290	11.3	290	11.3	290
Ramp angle	24°		24°		24°		24°	

When driving up steep ramps, on rough roads, over curbs, etc. it is important to remember that some parts of your car are close to the ground, such as spoilers or exhaust system components. Be sure to avoid damage.

TECHNICAL DATA

WEIGHTS

The vehicle capacity weight (max. load), the Gross Vehicle Weight Rating (GVWR), and the Gross Axle Weight Ratings (GAWR) for front and rear, are listed on the Safety Compliance Sticker on the left door-jamb.

The gross vehicle weight rating includes the weight of the basic vehicle plus full fuel tank, oil and coolant, plus max. load which combines passenger (150 pounds/68 kg per designated seating position) and luggage weight. Luggage weight is not increased by the use of a roof rack, unless passenger capacity is reduced accordingly.

The gross axle weight rating is the maximum load that can be applied at each axle of the vehicle.

Syncro

When driving off-road, the Gross Vehicle Weight (GVWR) must be reduced by 440 lbs (200 kg).

WARNING

■ **The actual gross axle weight rating at the front and rear axles should not exceed the permissible weights, and their combination must not exceed the Gross Vehicle Weight Rating.**

■ **Exceeding permissible weight ratings can result in vehicle damage, accidents and personal injury.**

Note

The vehicle capacity weight figures apply when the load is distributed evenly in the vehicle (passengers and luggage). When transporting a heavy load in the luggage compartment, the load should be carried as near to the rear axle as possible so that the vehicle's handling is not impaired. On no account should you exceed the maximum permissible axle loads or the maximum gross vehicle weight. Always remember that the vehicle's handling will be affected by the extra load, and adjust your speed accordingly.

Roof weights

The maximum permissible roof weight on the station wagon and kombi is 220 lb/100 kg. The roof luggage rack on the campmobile with pop-up roof allows only 110 lb/50 kg.

For more details see page 68.

Maximum permissible trailer weights

Braked trailer	900 kg (2,000 lb.)
Unbraked trailer	600 kg (1,320 lb.)
Tongue load	75 kg (165 lb.)

Do not exceed the weight limitations of your trailer hitch.

VEHICLE IDENTIFICATION

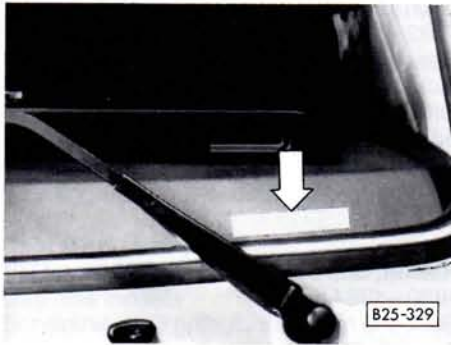

The Vehicle Identification Number (VIN)

is located on the instrument panel on the driver's side so that it is visible from the outside through the windshield.

The safety compliance sticker

is your assurance that your new vehicle complies with all applicable Federal Motor Vehicle Safety Standards which were in effect at the time the vehicle was manufactured. You can find this sticker on the left doorjamb. It shows the month and year of complete and incomplete (campmobile only) production and the vehicle identification number of your vehicle (perforation) as well as the Gross Vehicle Weight Rating and the Gross Axle Weight Rating.

1	SORT. NR.	<input type="text"/>
2	FAHRZG.-IDENT-NR. VEHICLE-IDENT-NO.	<input type="text"/>
3	TYP./TYPE	<input type="text"/>
4	<input type="text"/>	<input type="text"/>
5	MOTORKB. / GETR. KB. ENG. CODE / TRANS. CODE	<input type="text"/> <input type="text"/>
6	LACKNR. / INNENAUSST. PAINT NO. / INTERIOR	<input type="text"/> <input type="text"/> <input type="text"/>
7	M - AUSST. / OPTIONS	<input type="text"/>

B 17- 183

The Vehicle Identification Label

is located on the left side under the dashboard. The label contains the following information:

1. Production control no.
2. Vehicle identification no.
3. Type code number
4. Type designation
5. Engine and transmission code letter
6. Paint no./Interior
7. Optional equipment nos.

Vehicle data 2 to 7 are also found in your Maintenance booklet.



The Engine Number

is located on the right side of the engine block.

CONSUMER INFORMATION

SERVICE MANUALS

Note: Volkswagen service manuals are published as soon as possible after model introduction. Please call toll free **1-800-423-4595** in the United States and Canada from 8:30 AM to 5:00 PM Eastern time for the most up to date model year coverage, pricing and other information. Prices are subject to change without notice.

GTI, Golf and Jetta

1985–1989 models
Gasoline, Diesel and Turbo Diesel including Golf GT, Jetta GLI and 16V Service Manual by Robert Bentley, Inc. Volkswagen Part No. LPV 800 109
\$ 39.95

Volkswagen Fox

1987–1989 models including Wagon
Official Factory Repair Manual by Volkswagen United States
Volkswagen Part No. LPV 800 502
352 pages, 504 illustrations/diagrams
\$ 29.95

Scirocco and Cabriolet

1985–1989 models including 16 V
Official Factory Repair Manual by Volkswagen United States
Volkswagen Part No. LPV 800 110
\$ 39.95

Vanagon

1980–1989 models
Air-cooled and Water-cooled Gasoline and Diesel Engine, Syncro and Camper
Official Factory Repair Manual by Volkswagen United States
Volkswagen Part No. LPV 800 147
1264 pages, 2186 illustrations/diagrams
\$ 74.95

Quantum

1982–1986 models
Gasoline and Turbo Diesel including Wagon and Syncro
Official Factory Repair Manual by Volkswagen United States
Volkswagen Part No. LPV 800 201
1216 pages, 2066 illustrations/diagrams
\$ 59.95

Rabbit, Scirocco, Jetta and Pickup

1980–1984 models
Gasoline models including Convertible and GTI
Service Manual by Robert Bentley, Inc.
Volkswagen Part No. LPV 800 104
715 pages, 1151 illustrations/diagrams
\$ 29.95

Rabbit, Jetta and Pickup

1977–1984 models
Diesel and Turbo Diesel models
Service Manual
by Robert Bentley, Inc.
Volkswagen Part No. LPV 800 122
624 pages, 973 illustrations/diagrams
\$ 29.95

Rabbit and Scirocco

1975–1979 models
Gasoline models
Service Manual
by Robert Bentley, Inc.
Volkswagen Part No. LPV 997 174
628 pages, 1000 illustrations/diagrams
\$ 29.95

Dasher

1974–1981 models
including Diesel
Service Manual
by Robert Bentley, Inc.
Volkswagen Part No. LPV 997 335
692 pages, 1125 illustrations/diagrams
\$ 29.95

Fastback and Squareback

1969–1973 models
Official Service Manual Type 3
by Volkswagen United States
Volkswagen Part No. LPV 997 383
424 pages, 764 illustrations/diagrams
\$ 34.95

Station Wagon and Bus

1968–1979 models
Official Service Manual Type 2
by Volkswagen United States
Volkswagen Part No. LPV 997 288
464 pages, 753 illustrations/diagrams
\$ 34.95

Super Beetle, Beetle and Karmann Ghia

1970–1979 models
Official Service Manual Type 1
by Volkswagen United States
Volkswagen Part No. LPV 997 109
448 pages, 720 illustrations/diagrams
\$ 29.95

Beetle and Karmann Ghia

1966–1969 models
Official Service Manual Type 1
by Volkswagen United States
Volkswagen Part No. LPV 997 169
512 pages, 959 illustrations/diagrams
\$ 29.95

Order form on next page.

CONSUMER INFORMATION

Order Form

Mail to: **Volkswagen Service Manuals**
Robert Bentley, Inc.
1000 Massachusetts Avenue
Cambridge, MA 02138

Please send the following Volkswagen Service Manual:

Model _____ Model year _____

Check one: Gasoline Diesel

Volkswagen Part No. _____

My personal check is enclosed (Make payable to Robert Bentley, Inc.)

Price of manual: \$ _____

Shipping: \$ 3.95

Total enclosed: \$ _____

Charge my Master Card VISA Card American Express Card

Card Number _____ Expiration Date _____

Name _____

Street _____

City _____ State _____ Zip Code _____

Call toll free **1-800-423-4595** in the United States (1-617-547-4170 in Canada) for current pricing and other information.

Volkswagen Service Manuals

Volkswagen Service Manuals are available from Volkswagen Dealers in the United States and Canada. Manuals can also be ordered directly from:

Volkswagen Service Manuals
Robert Bentley, Inc.
1000 Massachusetts Avenue
Cambridge, MA 02138

1-800-423-4595 (United States and Canada)

Clip and mail this order form to obtain the Volkswagen Service Manual for your exact model Volkswagen.

For faster service, credit card customers in the United States and Canada can order toll free by calling **1-800-423-4595** or **1-617-547-4170** from 8:30 AM to 5:00 PM Eastern time. Master Card, VISA, and American Express credit cards are all welcome.

A shipping and handling charge of \$ 3.95 will be added to the price of each Manual UPS will be used whenever possible.

GAS STATION INFORMATION

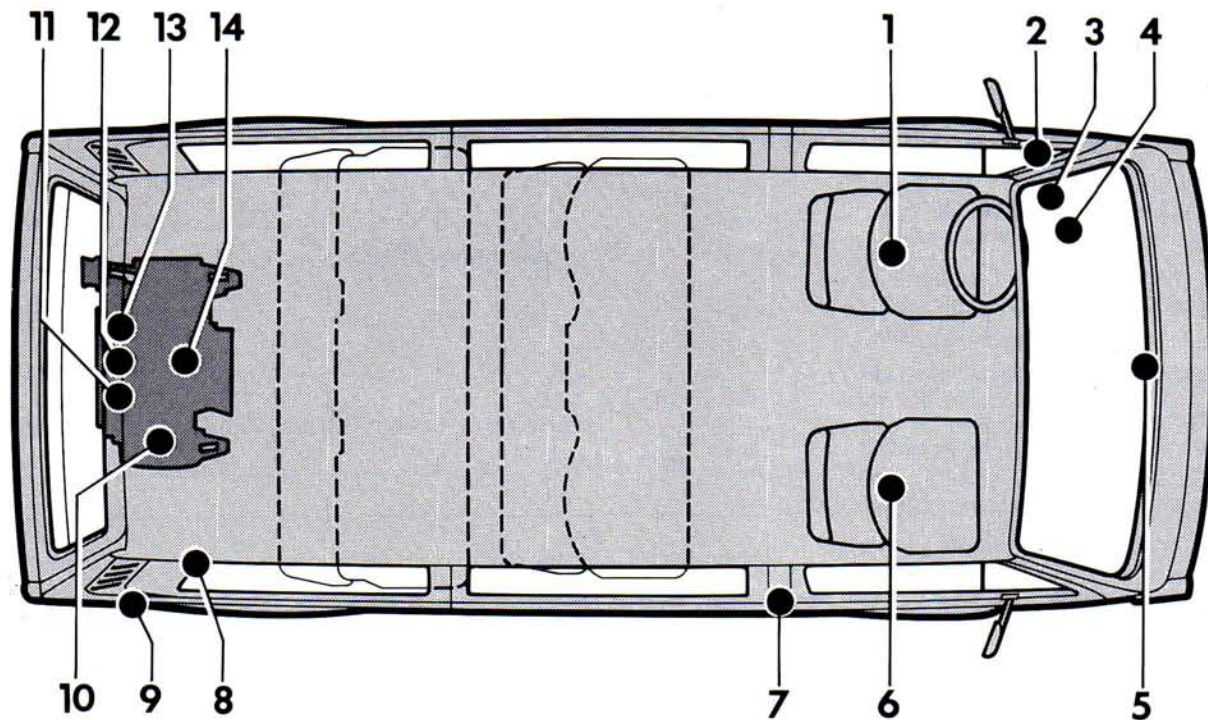

B25-625

- 1 – Jack and tools, see page 123.
- 2 – Windshield washer container, capacity 4.3 qt/4.2 liters.
- 3 – Fuse box, see page 128.
- 4 – Brake fluid reservoir, see page 108.
- 5 – Spare wheel, see page 124.
- 6 – Battery, see page 109.
- 7 – Fuel filler neck (rear wheel drive), capacity 16 gal/60 liters.
- 8 – Rear window washer container, capacity 1.1 qt/1.0 liters.
- 9 – Fuel filler neck (syncro), capacity 18.5 gal/70 liters.
- 10 – Air cleaner, see page 103.
- 11 – Power steering fluid reservoir, see page 103.
- 12 – Engine oil dipstick/oil filler neck, see page 99.
- 13 – Coolant refill tank, see page 105.
- 14 – ATF dipstick, see page 102.

ALPHABETICAL INDEX

	page		page		page
Accessories	122	Coolant temperature gauge	41	Engine oil checking	99
Air cleaner	103	Cooling system	104	Engine oil grades	98
Air Conditioner	54	Consumer information	152	Expansion tank	105
All-wheel-drive	75	Corrosion protection	94	Fan	41, 106
Alternator warning light	44	Cruise control	49	Folding table	65
Ashtrays	64	Curtains	27	Foreign country driving	120
Assist handles and coat hooks	67	Cup holder	66	Front seats	20
Automatic safety belts	14			Fuel economy	72
Automatic Transmission	35			Fuel gauge	42
Automatic Transmission Fluid	102			Fuel injection	142
Auxiliary Heater	57, 60	Dashboard	4	Fuel supply	86
		Data	146	Fuel tank	85
		Defogging/defrosting	52	Fuses	128
		Differential lock	33		
		Dimensions	148	Gas Station Information	156
		Do-it-yourself service	123	Gasoline additives	86
		Doors	9	Gearshift lever	32
				Glove compartment	64
Battery	109				
Battery charging	110	Economically driving	72	Headlight dimmer and flasher	48
Brake fluid reservoir	108	Electric windows	12	Headlights	130
Brake warning light	43	Emergency equipment	70	Headlight adjustment	134
Brakes	29	Emergency flasher	46	Headlight switch	46
Break-in period	69	Emergency starting	136	Head restraints	19
Bulb chart	130	Emergency towing	138	Heating/Ventilation	51
Bulb replacing	130	Emission Control System	144	High beam	45, 48
Buzzer	7, 35	Engine code letter	151	Horn	4
		Engine compartment lid	97		
		Engine cooling	41, 104	Identification label and number	151
Capacities	147	Engine exhaust	144	Ignition/steering lock	38
Catalytic converter	144	Engine number	151	Indicator lights	43
Central locking system	8	Engine oil changing	100		
Cigarette lighter	63				
Child safety	15				
Chime	7, 35				
Cleaning products	89				
Climate controls	51				
Clock	41				

ALPHABETICAL INDEX

	page		page		page
Introduction	2	Octane rating	86	Service manuals	152
Instrument illumination	46	Oil change	100	Side marker lights	132
Instrument panel	4	Oil filter changing	101	Sliding door	10
Instruments	40	Oil pressure warning light	43	Sliding roof	62
Interior light	63, 133	OXS (Oxygen sensor)	144	Sliding windows	12
				Snow chains	119
Jack and tools	123	Parking	31, 145	Spare wheel	124
Jack points	126	Parking brake	31	Spark plugs	146
		Pedals	29	Speedometer	40
Keys	7	Power steering	103	Speed ranges	69
Kickdown	37	Power windows	12	Starter switch	38
				Starting procedures	39
Lane changer	48	Radio	5, 135	Steering lock	38
License plate lights	133	Rear lid	11	Stopping engine	39
Lifting vehicle	140	Rear seat bench/bed combination	26	Sunroof	62
Light switch	46	Rear view mirrors	13	Sun visors	67
Light alloy wheels	92	Rear window defogger	47	Switches	46
Lights	46, 130	Rear window wiper/washer	50	Swivel seats	22
Locks	7	Refill Tank	105	Synco Differential lock	33
Lubricants	98	Reverse	32	Driving with the-all-wheel-drive	75
Luggage compartment	28	Roof rack	68	Snow chains	119
				Technical Information	142
Maintenance	95	Safe driving hints	70	Towing	139
Maintenance booklet	2	Safety belts	14		
Manual Transmission	32	Safety belts warning light	18	Tachometer	41
Manual Transmission Oil	102	Safety compliance sticker	151	Tail lights	132
Mirrors	13	Seats	20	Technical data	146
		Secondary heat exchanger	53		159
Notes to owner	2	Selector lever	35		

ALPHABETICAL INDEX

	page		page
Technical description	141	Washer jets adjusting	112
Temperature gauge	41	Washer reservoir	112
Tire specifications	117	Water temperature gauge	41
Tires	114	Water temperature warning light	41
Tools	123	Weights	150
Towing	138	Wheels	114
Trailer towing	73	Wheel changing	125
Trailer weights	150	Windows	12
Transmission oil	102	Windshield washer fluid container	112
Trip odometer	40	Windshield wiper/washer lever	50
Turn signal/headlight dimmer switch lever	48	Winter operation Battery	110
Undercoating	94	Cooling system	107
Unleaded fuel	85	Engine oil	98
Vanity mirror	67	Snow chains	119
V-belt	107, 147	Snow tires	118
Vehicle care	85	Vehicle care	90
Vehicle identification number/label	151	Windows	91
Vehicle operation	69	Windshield washer container	112
Ventilation/heating	51	Wiper blades	113
Warning and indicator light symbols	6		
Warning lights	43		
160 Warranty booklet	2		

Vanagon/Transporter
Nordamerika/englisch
8.89
901.551.250.21